

BS	VCC	GND
Interface	3-line SPI	4-line SPI

e-Paper

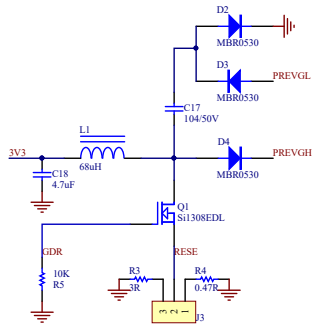
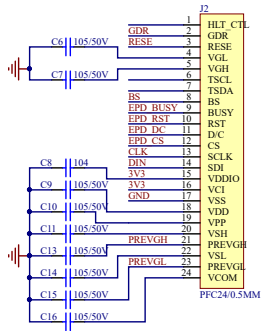

A (R2)	B (R3)
1.54inch	other
2.13inch	
2.9inch	

### Level conversion

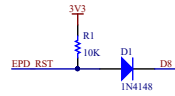
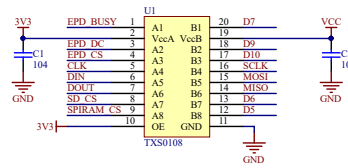

### SPI RAM

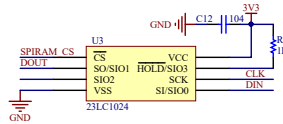

### SD Card

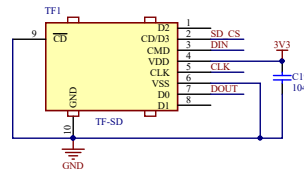

### Power

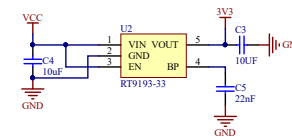

Waveshare

e-Paper Shield

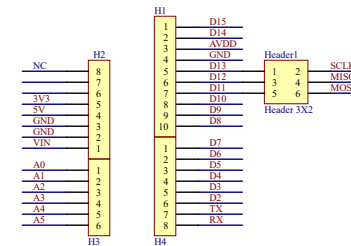
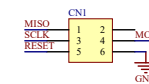
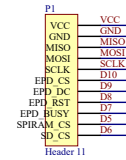

### Interface

				<b>Принципиальная схема</b>			
				Waveshare Arduino e-Paper Shield			
Изм.	Лист	№ Докум.	Подп.	Дата	Лит.	Масса	Масштаб
			Дементьев И				
Разраб.							
Пров.							
Т.Контр.							
Н.Контр.							
Утв.							
					Лист	Листов 1	