

300mA Low Dropout Low Noise LDO

Low Dropout Regulator

DESCRIPTION

The STL6118A series is a low dropout, low noise, low quiescent current linear regulator that operations in the input voltage range from +2.2V to +7.0V and delivers 300mA output current.

The high-accuracy output voltage is preset at an internally trimmed voltage 2.5V or 3.3V. Other output voltages can be mask-optional from 1.2V to 5.0V with 100mV increment, except STL6118A-LL which has 2.85V output voltage.

The STL6118A consists of a 1.25V band-gap reference, an error amplifier, and a P-channel pass transistor. Other features include short-circuit protection and thermal shutdown protection. The STL6118A devices are available in SOT-23, SOT-89.

FEATURE

- ◆ Low Current Consumption: 15μA(Typ.)
- ◆ Short Circuit Protection: 150mA
- ◆ Typical Dropout Voltage: 125mV@100mA(Typ.)
- ◆ Maximum Output Current: 300mA
- ◆ Output Current Limit Protection: 500mA
- ◆ Thermal Overload Shutdown Protection
- ◆ Low ESR Capacitor Compatible.

APPLICATIONS

- ◆ Battery Powered Equipment.
- ◆ Cameras, Video Cameras
- ◆ Portable Games
- ◆ Radio Communication Equipment
- ◆ Mobile Phone, Coreless Phone

PIN CONFIGURATION

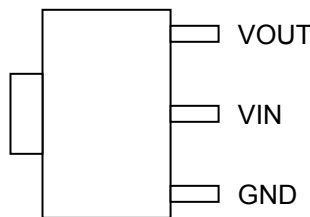

TOP VIEW
SOT-89

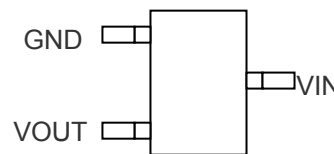

TOP VIEW
SOT-23

PART MARKING INFORMATION

<p>STL6118A-<u>XX</u> <u>X-XX</u> <u>X</u></p> <ul style="list-style-type: none"> — Lead Plating Code — Handling Code — Package Code — Voltage Code <p>Lead Plating Code G : Lead-free product. This product is RoHS compliant</p> <p>Handling Code TR : Tape&Reel TB : Tape&Box</p> <p>Package Code K : SOT-89 S : SOT-23</p> <p>Voltage Code XX : 12 / 15 / 18 / 25 / 285 / 30 / 33 / 36</p>	<p>Marking:</p> <div style="border: 1px solid black; width: 100px; height: 30px; margin: 10px auto; text-align: center; line-height: 30px;">2AVXX</div> <p>2A : STL6118A V : 5=1.2V, 8=1.5V, A=1.8V G=2.5V, L=2.85V, M=3.0V Q=3.3V, V=3.6V XX : Date code</p>
--	--

ORDERING INFORMATION

Part Number	SOT-89	Package Code	Package	VOUT Voltage	Shipping
STL6118A-XXK-TRG		K	SOT-89	1.2 1.5 1.8 2.5 2.85 3.0 3.3 3.6	3000/Tape&Reel
Part Number	SOT-23	Package Code	Package	VOUT Voltage	Shipping
STL6118A-XXS-TRG		S	TO-23	1.2 1.5 1.8 2.5 2.85 3.0 3.3 3.6	3000/Tape&Reel

Note:

※"XX"stands for output voltages.

※ G : Lead-free product. This product is RoHS compliant

ABSOLUTE MAXIMUM RATINGS ($T_A = 25^{\circ}\text{C}$ Unless otherwise noted)

Parameter	Symbol	Maximum	Unit
Power Dissipation	SOT-89	550	mW
	SOT-23	350	
Input voltage	V_{IN}	7.0	V
Output Current Limit	I_{OUT}	0.5	A
Operating Junction Temperature Range	T_J	+165	$^{\circ}\text{C}$
Storage Temperature Range	T_{STG}	-55~+150	$^{\circ}\text{C}$
Lead Soldering Temperature	T_{LEAD}	+260	$^{\circ}\text{C}$

Note: Exceeding these ratings could cause damage to the device. All voltages are with respect to Ground. Currents are positive into, negative out of the specified terminal.

ELECTRICAL CHARACTERISTICS ($T_A = 25^\circ\text{C}$ Unless otherwise noted)

 Operating conditions: $T_A=25^\circ\text{C}$, unless otherwise noted

Parameter	Symbol	Test Conditions	Min	Typ	Max	Unit
Input Voltage	V_{IN}	-	2.2		7.0	V
Output Voltage	V_{OUT}	$V_{IN}=V_{OUT}+0.8\text{V}$, $I_{OUT}=1\text{mA}$ $V_{OUT}\geq 2.5\text{V}$	-2%	V_{OUT}	+2%	V
Dropout Voltage	V_D	$V_{IN}\geq 2.5\text{V}$, $I_{OUT}=100\text{mA}$		125	140	mV
		$V_{IN}\geq 2.5\text{V}$, $I_{OUT}=200\text{mA}$		250	280	mV
		$V_{IN}\geq 2.5\text{V}$, $I_{OUT}=300\text{mA}$		550	650	mV
Maximum Load Current	I_{MAX}	$V_{OUT}+0.8\text{V}\leq V_{IN}\leq 7.0\text{V}$	300			mA
Short Circuit Current	I_{SC}	$V_{IN}\geq V_{OUT}+0.8\text{V}$, $V_{OUT}=0\text{mV}$		150		mA
Quiescent Current	I_Q	$V_{IN}=V_{OUT}+0.8\text{V}$, $I_{OUT}=0\text{mA}$		15	30	μA
Line Regulation	V_{SR}	$V_{OUT}+0.8\text{V}\leq V_{IN}\leq 7.0\text{V}$ $I_{OUT}=1\text{mA}$		0.2	0.3	%/V
Load Regulation	V_{LR}	$0\text{mA}\leq I_{OUT}\leq 300\text{mA}$ $V_{IN}=V_{OUT}+0.8\text{V}$		0.01	0.02	%/mA
Ripple Rejection	R_A	$f=1\text{KHz}$, $I_{OUT}=30\text{mA}$, $C_{OUT}=1\mu\text{F}$		65		dB
Thermal Shutdown Temperature	T_{SD}			150		$^\circ\text{C}$
Thermal Shutdown Hysteresis	T_{HYS}			20		$^\circ\text{C}$

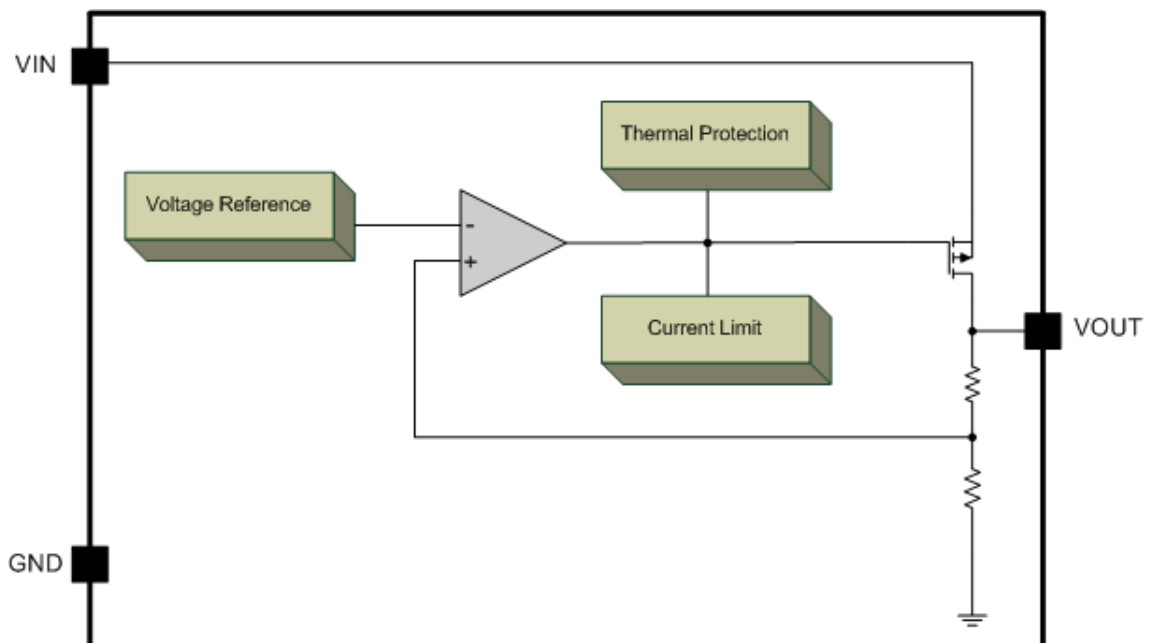
FUNCTION BLOCK DIAGRAM

TYPICAL APPLICATIONS

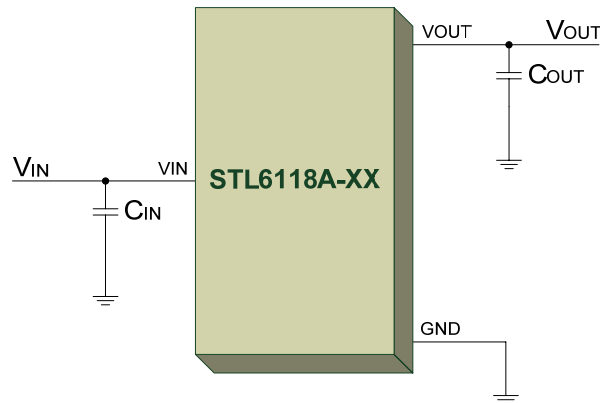

$$C_{IN}=3.3\mu A$$

$$C_{OUT}=1\mu A$$

APPLICATION INFORMATION

◆ Detail Description

The STL6118A is a low-dropout linear regulator. The device provides preset 2.5V and 3.3V output voltages for output current up to 300mA. Other mask options for special output voltages from 1.2V to 5.0V with 100mV increment are also available (but only 1.28V instead of 1.3V). As illustrated in function block diagram, it consists of a 1.25V reference, error amplifier, a P-channel pass transistor, and an internal feedback voltage divider.

The 1.25V bandgap reference is connected to the error amplifier, which compares this reference with the feedback voltage and amplifies the voltage difference. If the feedback voltage is lower than the reference voltage, the pass-transistor gate is pulled lower, which allows more current to pass to the output pin and increases the output voltage. If the feedback voltage is too high, the pass-transistor gate is pulled up to decrease the output voltage.

The output voltage is feedback through an internal resistive divider connected to V_{OUT} pin. Additional blocks include with output current limiter and shutdown logic.

◆ Internal P-channel Pass Transistor

The STL6118A features a P-channel MOSFET pass transistor. Unlike similar designs using PNP pass transistors, P-channel MOSFETs require no base drive, which reduces quiescent current. PNP-based regulators also waste considerable current in dropout conditions when the pass transistor

saturates, and use high base-drive currents under large loads. The STL6118A does not suffer from these problems and consumes only 15 μ A (Typical) of current consumption under light loads.

◆ Output Voltage Selection

The STL6118A output voltage is preset at an internally trimmed voltage 1.8V, 2.5V or 3.3V. The output voltage also can be mask-optioned from 1.2V to 5.0V with 100mV increment. The first two digits of part number suffix identify the output voltage (see *Ordering Information*). For example, STL6118A-33 has a preset 3.3V output voltage.

◆ Current Limit

The STL6118A also includes a fold back current limiter. It monitors and controls the pass-transistor's gate voltage, estimates the output current, and limits the output current within 500mA.

◆ Thermal Overload Protection

Thermal overload protection limits total power dissipation in the STL6118A. When the junction temperature exceeds $T_J = +150^{\circ}C$, a thermal sensor turns off the pass transistor, allowing the IC to cool down. The thermal sensor turns the pass transistor active again after the junction temperature cools down by $20^{\circ}C$ resulting in a pulsed output during continuous thermal overload conditions.

Thermal overload protection is designed to protect the STL6118A in the event of fault conditions. For

continuous operation, the maximum operating junction temperature rating of $T_J=+125^{\circ}\text{C}$ should not be exceeded.

◆ **Operating Region and Power Dissipation**

Maximum power dissipation of the STL6118A depends on the thermal resistance of the case and circuit board, the temperature difference between the die junction and ambient air, and the rate of airflow. The power dissipation across the devices is $P = I_{\text{OUT}} \times (V_{\text{IN}} - V_{\text{OUT}})$. The resulting maximum power dissipation is:

$$P_{\text{MAX}} = (T_J - T_A) / \theta_{\text{JC}} + \theta_{\text{JA}} = (T_J - T_A) / \theta_{\text{JA}}$$

Where $(T_J - T_A)$ is the temperature difference between the STL6118A die junction and the surrounding air, θ_{JC} is the thermal resistance of the package chosen, and θ_{CA} is the thermal resistance through the printed circuit board, copper traces and other materials to the surrounding air. For better heat-sinking, the copper area should be equally shared between the V_{IN} , V_{OUT} , and GND pins.

■ TYPICAL CHARACTERISTICS (25°C Unless Note)

Output Voltage VS. Output Current

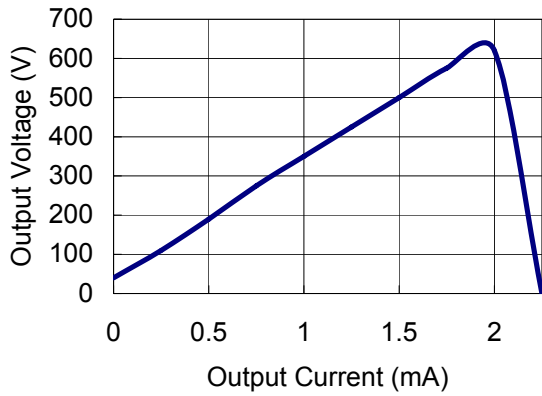

Supply Current VS. Input Voltage

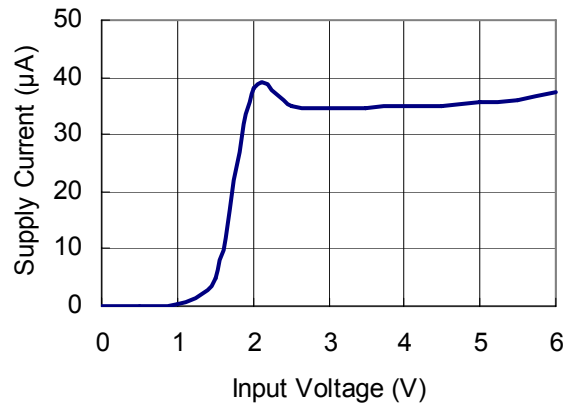

Output Voltage VS. Ambient Temperature

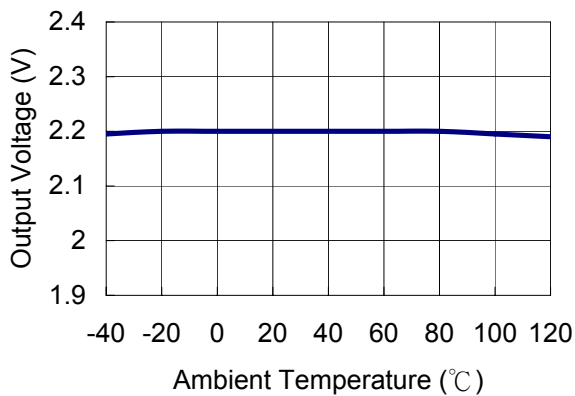

Supply Current VS. Ambient Temperature

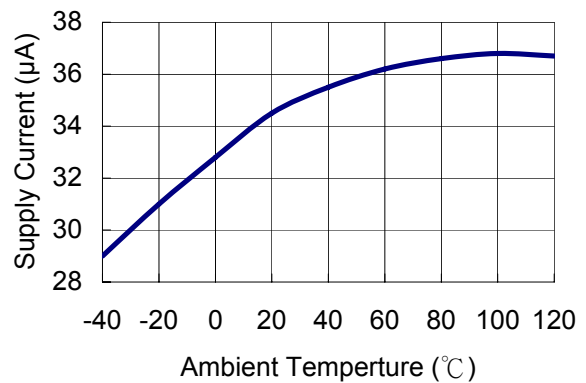

Dropout Voltage VS. Output Current

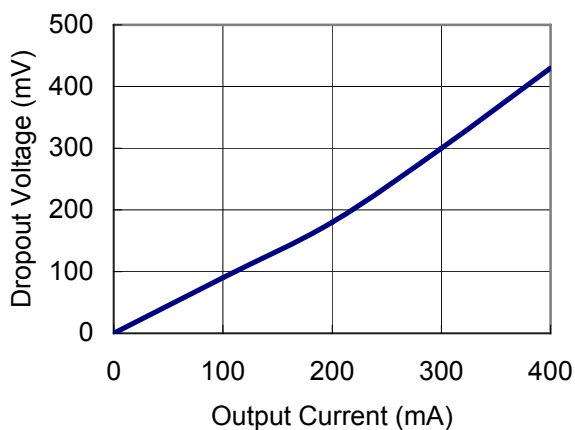

Supply Current VS. Output Current

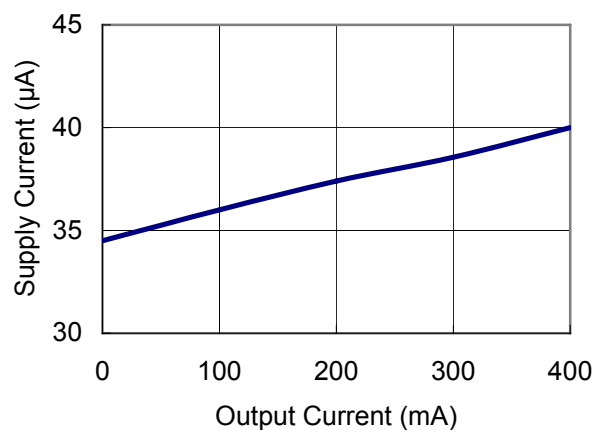

Output Voltage VS. Input Voltage

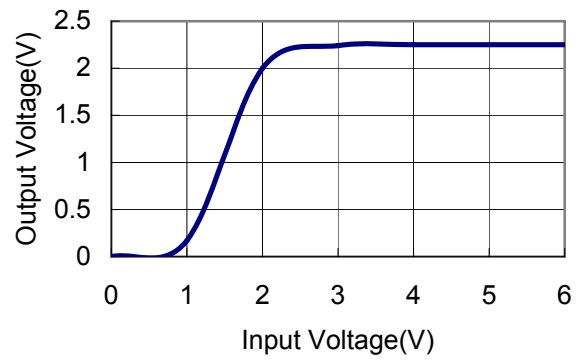

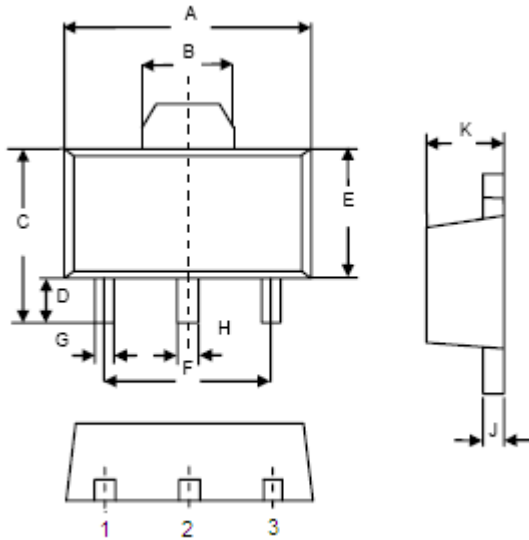
SOT-89 PACKAGE DIMENSIONS

Symbol	Inches		Millimeters	
	Min	Max	Min	Max
A	.173	.181	4.40	4.60
B	.055	.071	1.40	1.80
C	.154	.165	3.91	4.19
D	.035	.043	0.90	1.10
E	.091	.102	2.3	2.6
F	.114	.122	2.90	3.10
G	.013	.020	0.32	0.52
H	.014	.022	0.36	0.56
J	.014	.017	0.35	0.44
K	.055	.063	1.40	1.60

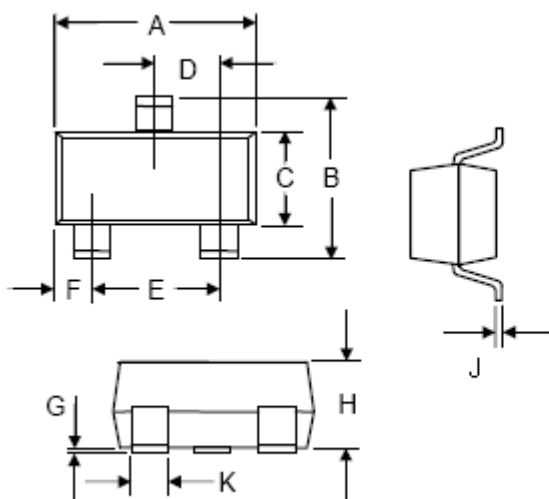
SOT-23 PACKAGE DIMENSIONS

Symbol	Inches		Millimeters	
	Min	Max	Min	Max
A	0.110	0.120	2.80	3.04
B	0.83	0.098	2.10	2.64
C	0.47	0.055	1.20	1.40
D	0.35	0.041	0.89	1.03
E	0.70	0.081	1.78	2.05
F	0.18	0.024	0.45	0.60
G	0.001	0.0039	0.013	0.100
H	0.035	0.044	0.89	1.12
J	0.003	0.007	0.085	0.18
K	0.015	0.02	0.37	0.51