

BS	VCC	GND
Interface	3-line SPI	4-line SPI

A (R1)	B (R2)
1.54inch	1.54inch (B)
2.13inch	2.13inch (B)
2.9inch	2.7inch
	2.7inch (B)
	2.9inch (B)
	4.2inch
	4.2inch (B)
	7.5inch
	7.5inch (B)

e-Paper

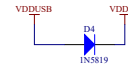
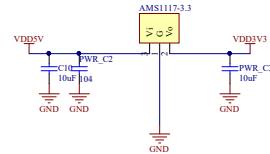

Power

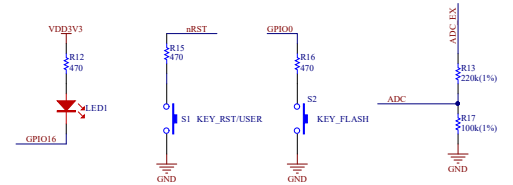

Key and ADC

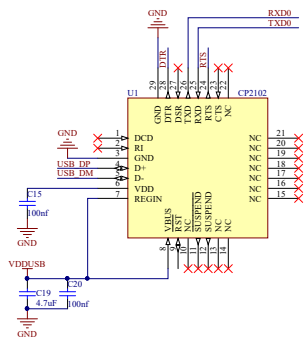

AUTO PROGRAM CIRCUIT				
DTR	RTS	RST	GPI00	
1	1	1	1	1
1	0	0	1	1
1	1	0	0	1
0	1	1	0	1

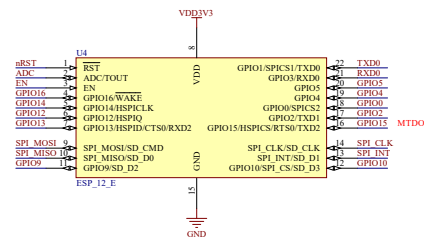
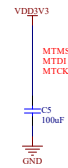
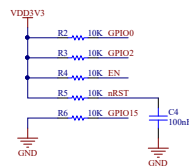

ESP-12E

ADC_EX	A0	1	14	15	16
ADC	RESV	2	PIN1	1	DO GPIO16
RESV	3	PIN2	2	DI GPIO5	
SD_D3 GPIO10	D12	4	PIN3	3	GPIO4
SD_D1 SPI INT	D11	5	PIN4	4	DI GPIO0
SD_CMD SPI MOSI	6	PIN5	5	DA GPIO2	TXD1
SD_D0 SPI MISO	7	PIN6	6	VDD3V3	
SD_CLK SPI CLK	8	PIN7	7	GND	
GND	9	PIN8	8	DS GPIO14	ISPICK
VDD3V3	10	PIN9	9	DS GPIO12	ISPICK
EX	11	PIN10	10	DT GPIO13	RXD1 ISPICK
nRST	12	PIN11	11	DS GPIO15	TXD1 ISPICK
EN	13	PIN12	12	DS GPIO16	TXD1 ISPICK
GPIO16	14	PIN13	13	D10 TXD0	GPIO1
GPIO14	15	PIN14	14	GND	
GPIO12	16	PIN15	15	VDD3V3	
GPIO13					

THT_Male_P_1x15

IO Connectors

USB to UART

D

D

Comment	Description	Designator	Footprint	LibRef	Quantity
AMS1117-3.3		AMS-1	SOT-223	AMS1117	1
C_0603	Capacitor	C1, C2, C3, C6, C7, C8, C9, C12, C13, C16, C17, C18	C0603	C_0603	12
100nF	Surface mount capacitor 0402	C4	C0603	SMT_C_0402	1
100uF	Capacitor	C5	1206	Cap	1
10uF	Capacitor	C10, PWR_C3	1206	Cap	2
104	Capacitor	C15, C20	C0603	Cap	2
4.7uF	Capacitor	C19	C0603	Cap	1
MBR0530	Diode	D1, D2, D3	SOD123	DIODE	3
1N5819	1 Amp General Purpose Rectifier	D4	SOD-323	Diode 1N	1
PFC24/0.5MM	Connector	J2	24PIN ZZ - up	CON24	1
CON3	Connector	J3	SWITCH2-1 7P	CON3	1
THT_Male_P_1x15	THT Male pin header strip 1x15	J4, J5	HEADER SMT 15X1 2.54 B	THT_Male_P_1x15	2
68uH		L1	inductance	Inductance	1
LED_0805		LED1	0805_LED	LED_0805	1
waveshare_logo		logo1	WS_symbol_M_new	waveshare_logo	1
104	Capacitor	PWR_C2	0603	Cap	1
Si1304BDL		Q1	SOT-23(SC70)	MOSFET N	1
10K	Resistor	R2, R3, R4, R5, R6, R7, R8, R10, R11, R12, R13, R15, R16, R17	0603	Res1	14
R_0603	Resistor	R9	0603	R_0603	1
NC	Resistor	R18	0603	Res1	1
0R	Resistor	R19	0603	Res1	1
KEY_RST/USER		S1	SMT_SW_PTS_820	KEY	1
KEY_FLASH		S2	SMT_SW_PTS_820	KEY	1
CP2102	CP2102	U1	CP2102_QFN28	CP2102	1
ESP_12_E	ESP-12 Wi-Fi Module by AI-Thinker	U4	ESP_12_E_L	ESP_12_E	1
USB		USB.J1	MICRO USB 5P - DUPLICATE	USB	1
S8050		VT1, VT2	SMT_TRIODE_NPN	NPN_SOT23	2