



JN Huamao Technology Co., Ltd.

Bluetooth 4.0 BLE module

Datasheet

- 2 Professional Bluetooth products suppliers.
- 2 Remote control module provider
- 2 Data transmission module provider
- 2 PIO state acquisition module provider
- 2 Customizable Bluetooth modules and Bluetooth solutions
- 2 Jinan high and new technology enterprise
- 2 SIG members

Address: D-4020, Qilu soft zone Jinan city, Shandong, China

Telephone: (86) 0531-85117999

WebSite: <http://www.jnhuamao.cn>

WebSite: <http://www.huamaosoft.com>

Mail: webmaster@jnhuamao.cn

**The most complete, most convenient, the most stable of
Bluetooth data transmission, Remote control and PIO input
status acquisition module**

---- Master and slave role in one

---- Remote control PIO with AT Commands

---- Remote acquisition of PIO input status with AT Commands

1. Product Parameters

- Ø BT Version: Bluetooth Specification V4.0 BLE
- Ø Working frequency: 2.4GHz ISM band
- Ø Modulation method: GFSK(Gaussian Frequency Shift Keying)
- Ø RF Power: -23dbm, -6dbm, 0dbm, 6dbm
- Ø Speed: Asynchronous: 2-6K Bytes
Synchronous: 2-6K Bytes
- Ø Security: Authentication and encryption
- Ø Service: 0xFFE0 (Modifiable use AT+UUID command)
- Ø Characteristic: 0xFFE1 (Modifiable use AT+UUID command)
- Ø Characteristic: Notify and Write (Modifiable use AT+UUID command)
- Ø Power: +2.5V~3.3VDC 50mA
- Ø Power: Active state 8.5mA; Sleep state 50~200uA
- Ø Working temperature: -20 ~ +95 Centigrade
- Ø Size: HM-10 27mm x 13mm x 2.2 mm
- Ø Size: HM-11 18mm x 13mm x 2.2mm
- Ø Size: HM-15 65mm x 32mm x 16mm

2. Product overview

First of all, Thank you for choose our Bluetooth products.

If you want to know more about us, www.inhuamao.cn could help you (Videos, New version datasheet, Module work flow, project Codes, etc.)

HM Bluetooth modules use CSR or TI CC2xxx or cypress chips, Master and slave roles in one, data transmission version and remote control version and PIO status acquisition version in one, Support the AT commands modify module parameters, Convenient and flexible.

Data Transmission version:

Before connect:

You can configure module parameters with AT Commands through UART

After connect:

- 1) Send and receive Bluetooth data through UART.

Remote Control version:

Before connect:

You can configure module parameters with AT Commands through UART

After connect:

- 1) Send and receive Bluetooth data through UART.
- 2) Remote device could configure module parameters with AT Commands
- 3) Remote device could control PIO2~PIO11 output low or high

PIO acquisition version:

Before connect

You can configure module parameters with AT Commands through UART

After connect

- 1) Send and receive Bluetooth data through UART.
- 2) Remote device could configure module parameters with AT Commands
- 3) Remote device could control PIO2, 3 output low or high with AT Commands

HM-11 has no this function

- 4) Remote device could get PIO4 ~ 11 input status with AT Commands

HM-11 only has PIO2 and PIO3.

Module version:

HM-01 to HM-09 is Bluetooth V2.1 version.

HM-10, HM-11 is Bluetooth V4.0 BLE version.

HM-12, HM-13 is Bluetooth Dual mode support EDR 4.0 and BLE 4.0

HM-16, HM-17 is Bluetooth V4.1 BLE version.

HM-18, HM-19 is Bluetooth V4.2 and V5.0 BLE version.

HM-01, HM-02, HM-09, HM-10, HM-16 and HM-18 is Pins to Pins.

HM-05, HM-06, HM-07, HM-11, HM-17 and HM-19 is Pins to Pins.



3. Product model





Modules	VDD	Size(mm)	Flash	Chip	BT Version
HM-01	2.5-3.7V	27 * 13 * 2.2	8M	BC417143	V2.1+EDR
HM-02A	2.5-3.7V	27 * 13 * 2.2	6M	BC31A223	V2.1
HM-02B	2.5-3.7V	27 * 13 * 2.2	6M	BC41C671	V2.1+EDR
HM-03A	2.5-3.7V	27 * 12.5 * 4.3	6M	BC31A223	V2.1
HM-03B	2.5-3.7V	27 * 12.5 * 4.3	6M	BC41C671	V2.1+EDR
HM-04A	2.5-3.7V	Not for sale			
HM-04B	2.5-3.7V	Not for sale			
HM-05/06A	2.5-3.7V	18 * 13 * 2.2	6M	BC31A223	V2.1
HM-05/06B	2.5-3.7V	18 * 13 * 2.2	6M	BC41C671	V2.1+EDR
HM-07	2.5-3.7V	18 * 13 * 2.2	8M		V2.1+EDR
HM-08	2.5-3.7V	27 * 13 * 2.5	8M	Class 1	V2.1+EDR
HM-09	2.5-3.7V	27 * 13 * 2.2	8M		V2.1+EDR
HM-10	2.2-3.7V	27 * 13 * 2.2	256Kb	CC2540/1	V4.0 BLE
HM-11	2.2-3.7V	18 * 13 * 2.2	256Kb	CC2540/1	V4.0 BLE
HM-12	2.5-3.9V	27 * 13 * 2.2	64KB	Dual mode	EDR 40 + BLE 40
HM-13	2.5-3.9V	18 * 13 * 2.2	64KB	Dual mode	EDR 40 + BLE 40
HM-14	2.2-4.0V	13 * 12 * 2.0		Dual mode	EDR40 + BLE 40
HM-15	5V	65 * 32 * 16	256Kb	CC2540	BLE V4.0
HM-16	2.1-5.5V	27 * 13 * 2.2	128KB		BLE V4.1
HM-17	2.1-5.5V	18 * 13 * 2.2	128KB		BLE V4.1
HM-18	2.1-5.5V	27 * 13 * 2.2	256KB		BLE V4.2 & V5.0
HM-19	2.1-5.5V	18 * 13 * 2.2	256KB		BLE V4.2 & V5.0

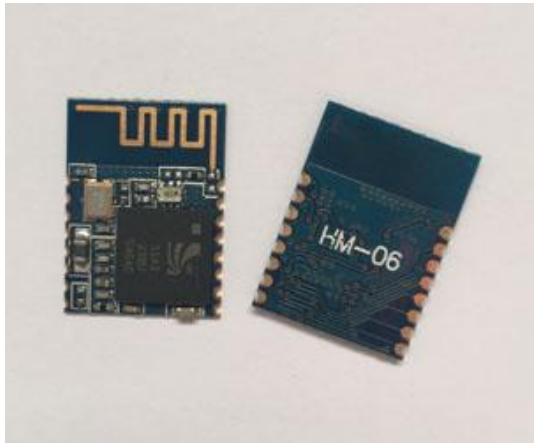
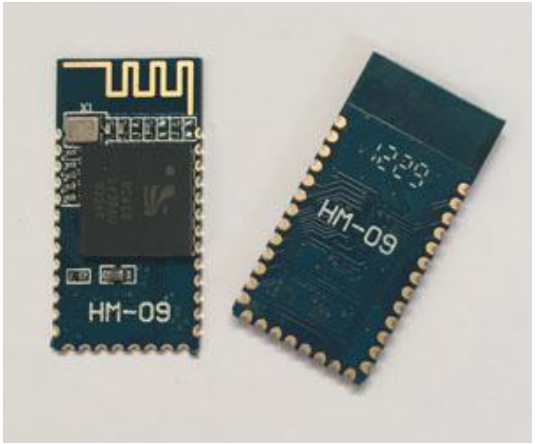
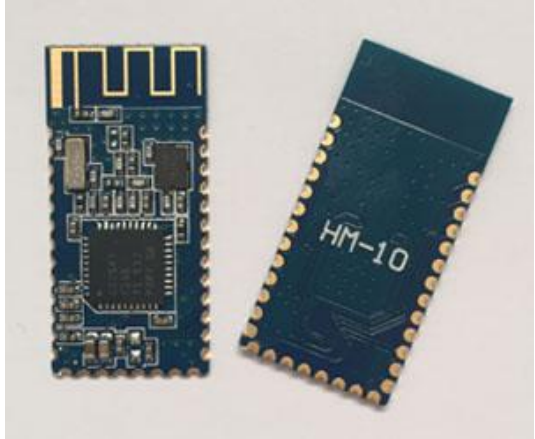

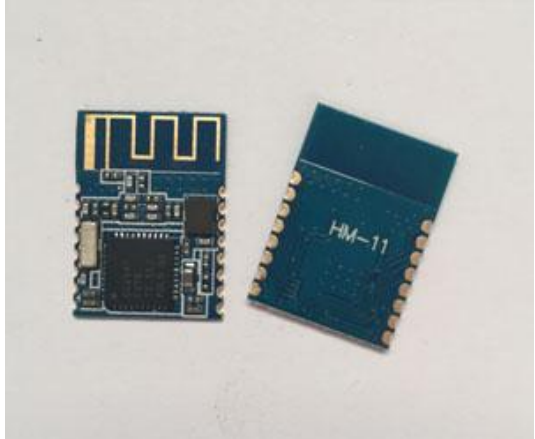
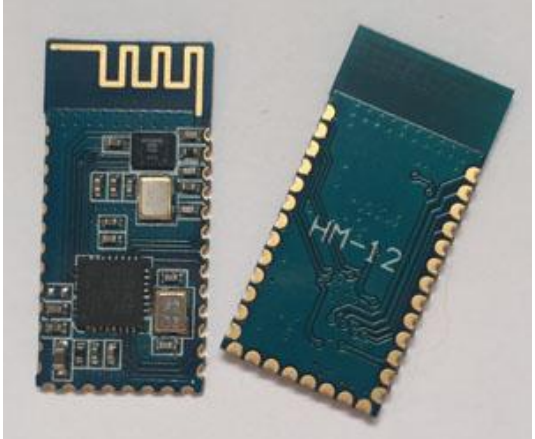
4. Product certificate

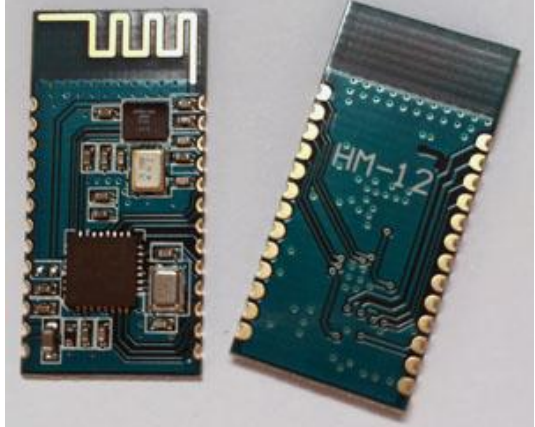
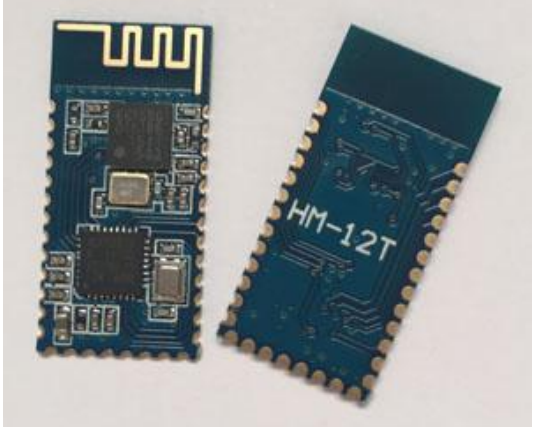
Products have FCC-ID, CE, RoHS. You can download certification from www.jnhuamao.cn or www.huamaosoft.com

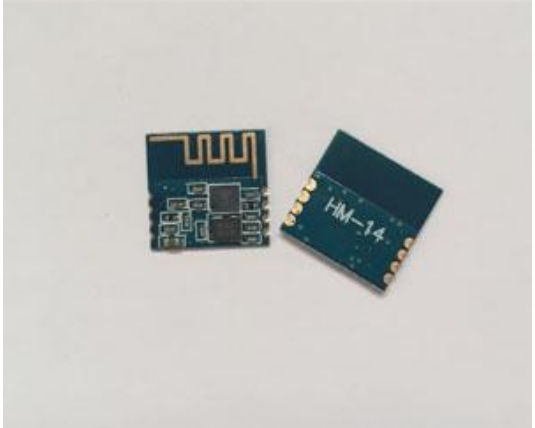
5. Product pictures

	
<p>HM-06 EDR 2.1 HMSoft</p>	<p>HM-09 EDR 2.1 HMSoft</p>
	
<p>HM-10S BLE 4.0 HMSoft</p>	<p>HM-10C BLE 4.0 HMSoft</p>
	
<p>HM-11 BLE 4.0 HMSoft</p>	<p>HM-12S Dual (EDR 4.0 & BLE 4.0) HMSoft</p>

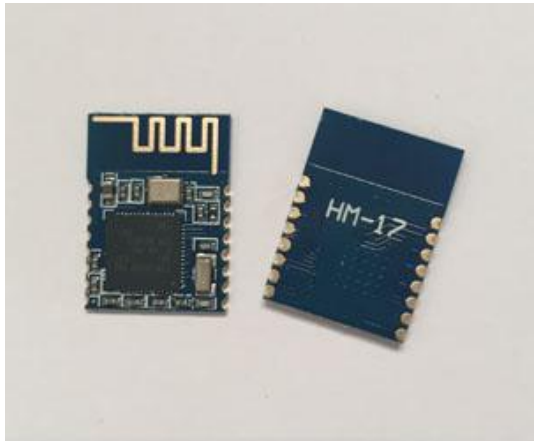
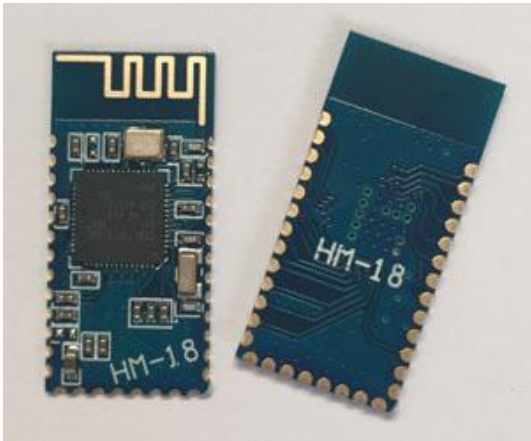
	
<p>HM-12C Dual (EDR 4.0 & BLE 4.0) HMSoft</p>	<p>HM-12T Dual (EDR 4.0 & BLE 4.0) HMSoft</p>
	
<p>HM-13 Dual (EDR 4.0 & BLE 4.0) HMSoft</p>	<p>HM-14 Dual (EDR 4.0 & BLE 4.0) HMSoft</p>
	
<p>HM-15 BLE 4.0 USB Dongle HMSoft</p>	<p>HM-16 BLE 4.1 HMSoft</p>

	
<p align="center">HM-17 BLE 4.1 HMSoft</p>	<p align="center">HM-18 BLE 4.2 HMSoft</p>
	
<p align="center">HM-19 BLE 4.2 HMSoft</p>	<p align="center">HM Beacon BLE 4.0 HMBeacon</p>
<p align="center">WIFI Testing Coming soon</p>	<p align="center">WIFI+BLE Testing Coming soon</p>
<p align="center">HM-20</p>	<p align="center">HM-21</p>

6. Product technical specifications

This document only include Bluetooth BLE 4.0 document, If you want to know more about other modules, www.inhuamao.cn or www.huamaosoft.com could help you.

What's different between HM-10S and HM-10C?

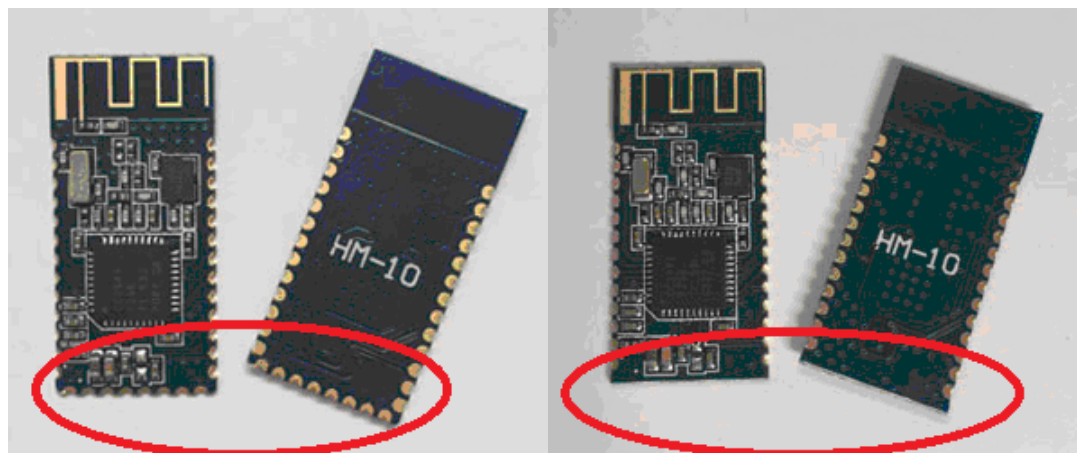

Left is HM-10S, It have 34 Pads. Right is HM-10C and it only have 26 Pads

HM-10C is cheaper than HM-10S.

6.1 HM-10 Schematic

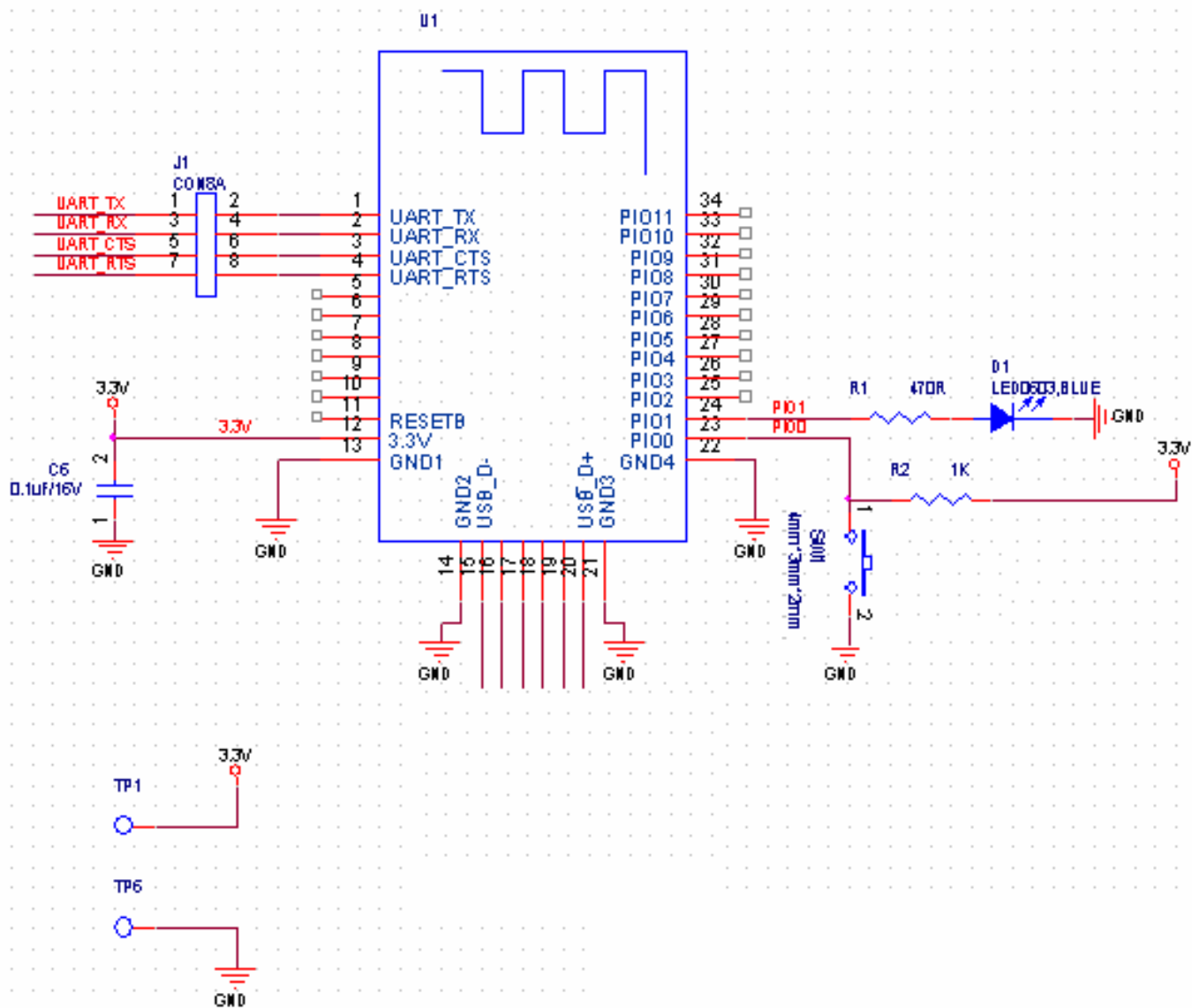

6.2 HM-10 Size

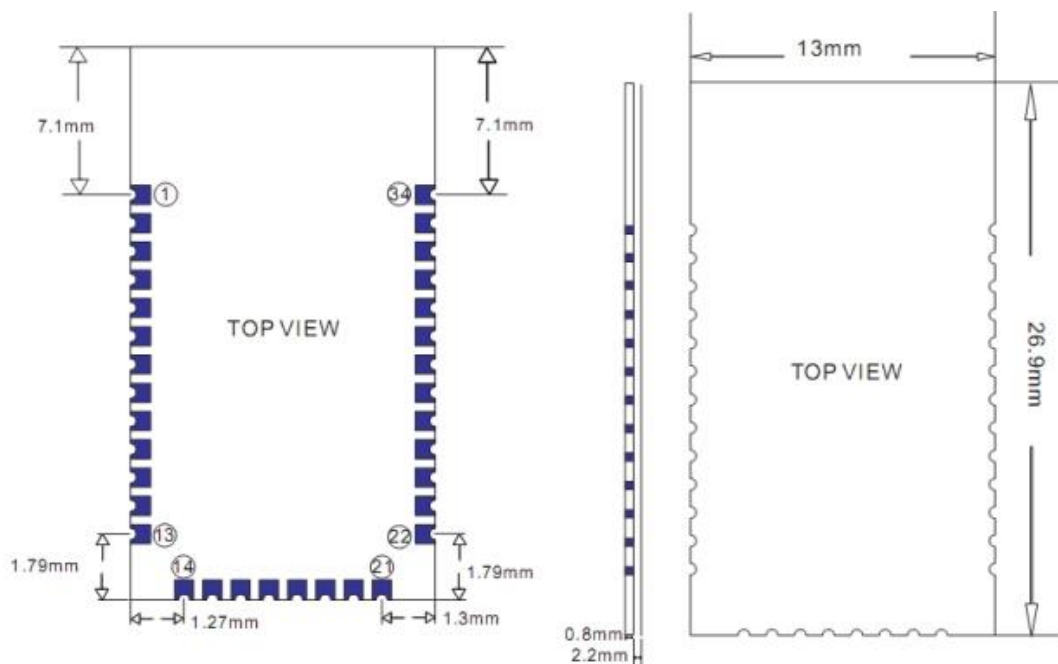

6.3 HM-10 package information

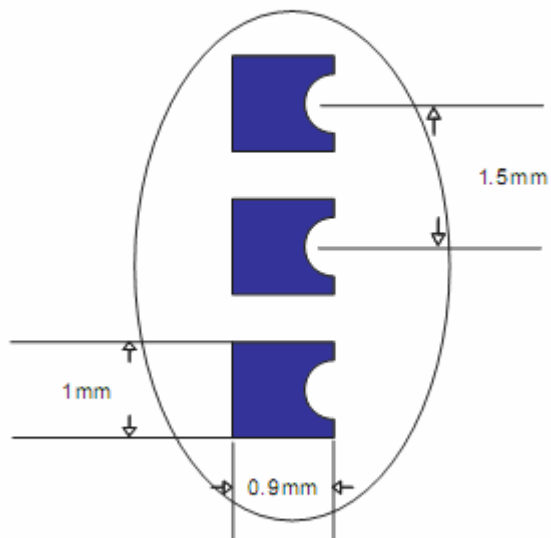

6.4 HM-10 Device Terminal Functions

HM-10S	HM-10C	Name	Description	CC254X
1	1	UART_TX	UART interface	P1_6
2	2	UART_RX	UART interface	P1_7
3	3	UART_CTS	UART interface	P1_4

4	4	UART_RTS	UART interface	P1_5
5	5	NC	NC	
6	6	NC	NC	
7	7	NC	NC	P2_2
8	8	NC	NC	P2_1
9	9	NC	NC	P2_0
10	10	NC	NC	
11	11	RESETB	Reset if low >100ms.	RESET
12	12	VCC	3.3V	
13	13	GND	Ground	
14	X	GND	Ground HM-10C doesn't have this pin	
15	X	USB_D-	USB interface HM-10C doesn't have this pin	PIN3
16	X	NC	NC HM-10C doesn't have this pin	
17	X	NC	NC HM-10C doesn't have this pin	
18	X	NC	NC HM-10C doesn't have this pin	
19	X	NC	NC HM-10C doesn't have this pin	
20	X	UB_D+	USB interface HM-10C doesn't have this pin	PIN2
21	X	GND	Ground HM-10C doesn't have this pin	GND
22	22	GND	Ground	GND
23	23	PIO0	System Key	P1_3
24	24	PIO1	System LED	P1_2

25	25	PIO2	input/output pin. PWM output	P1_1
26	26	PIO3	input/output pin/ADC	P1_0
27	27	PIO4	input/output pin/ADC	P0_7
28	28	PIO5	input/output pin/ADC	P0_6
29	29	PIO6	input/output pin/ADC	P0_5
30	30	PIO7	input/output pin/ADC	P0_4
31	31	PIO8	input/output pin/ADC	P0_3
32	32	PIO9	input/output pin/ADC	P0_2
33	33	PIO10	input/output pin/ADC	P0_1
34	34	PIO11	input/output pin/ ADC/DS18B20/DHT11	P0_0

6.5 HM-11 Size

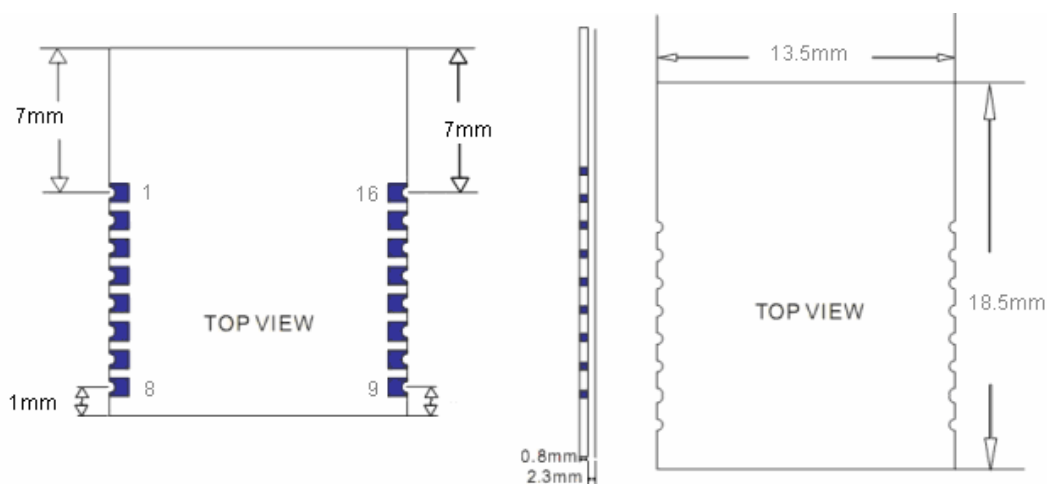

6.6 HM-11 Package information

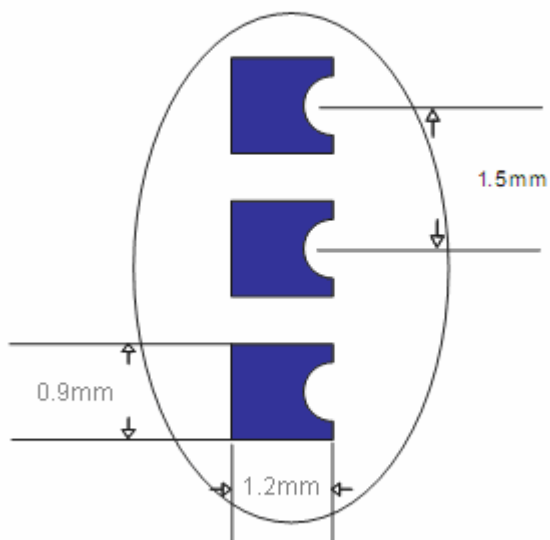

6.7 HM-11 Device Terminal Functions

No	Name	Description	CC254X
1	UART_RTS	UART interface	P1_5
2	UART_TX	UART interface	P1_6
3	UART_CTS	UART interface	P1_4
4	UART_RX	UART interface	P1_7
5	NC	NC	P2_1
6	NC	NC	P2_2
7	NC	NC	PIN2
8	NC	NC	PIN3
9	VCC	V3.3	VCC
10	NC	NC or VCC	
11	RESETB	Reset if low >100ms	RESET_N
12	GND	Ground	GND
13	PIO3	input/output pin	P1_1
14	PIO2	input/output pin/PWM	P1_0

15	PIO1	System LED	P0_7
16	PIO0	System KEY	P0_6

6.8 HM-15

HM-15 is based HM-10, a real USB interface.

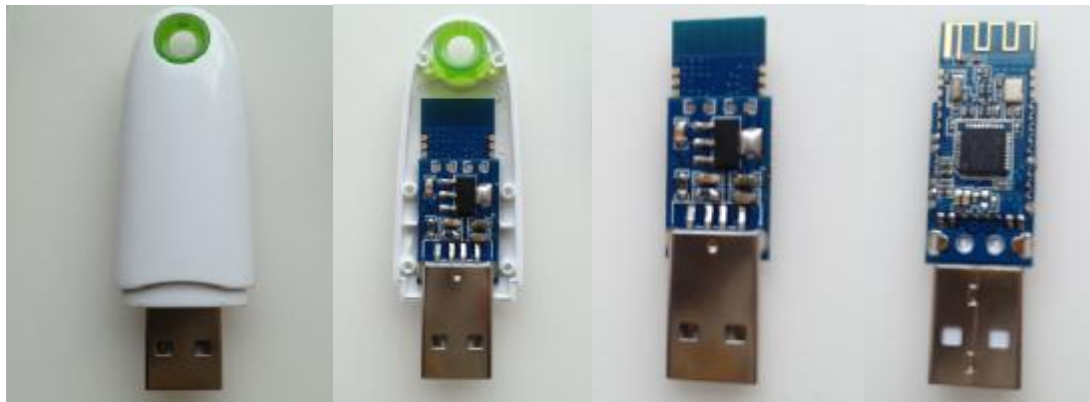

6.9 HM-Sensor

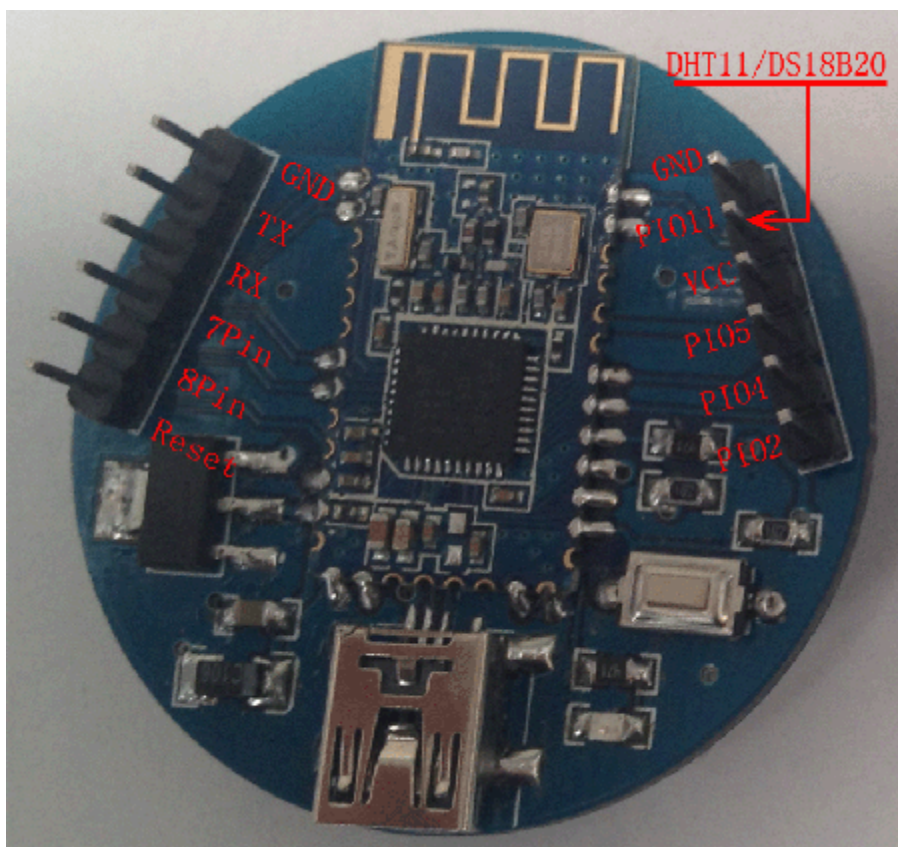

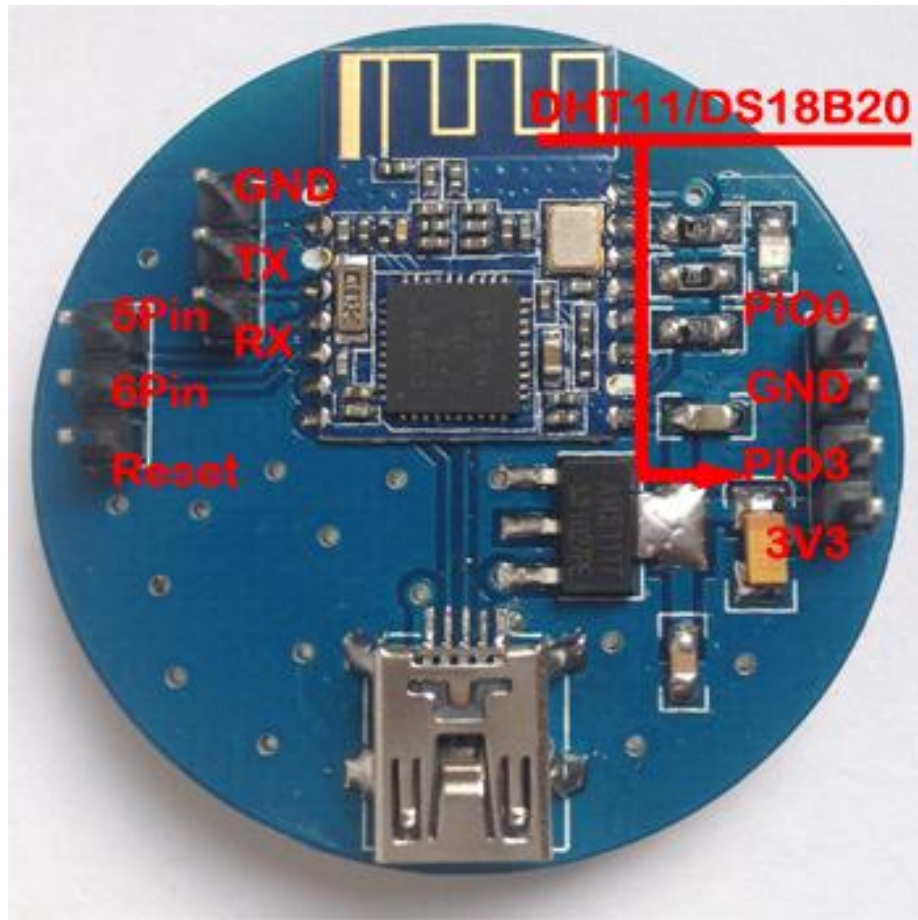

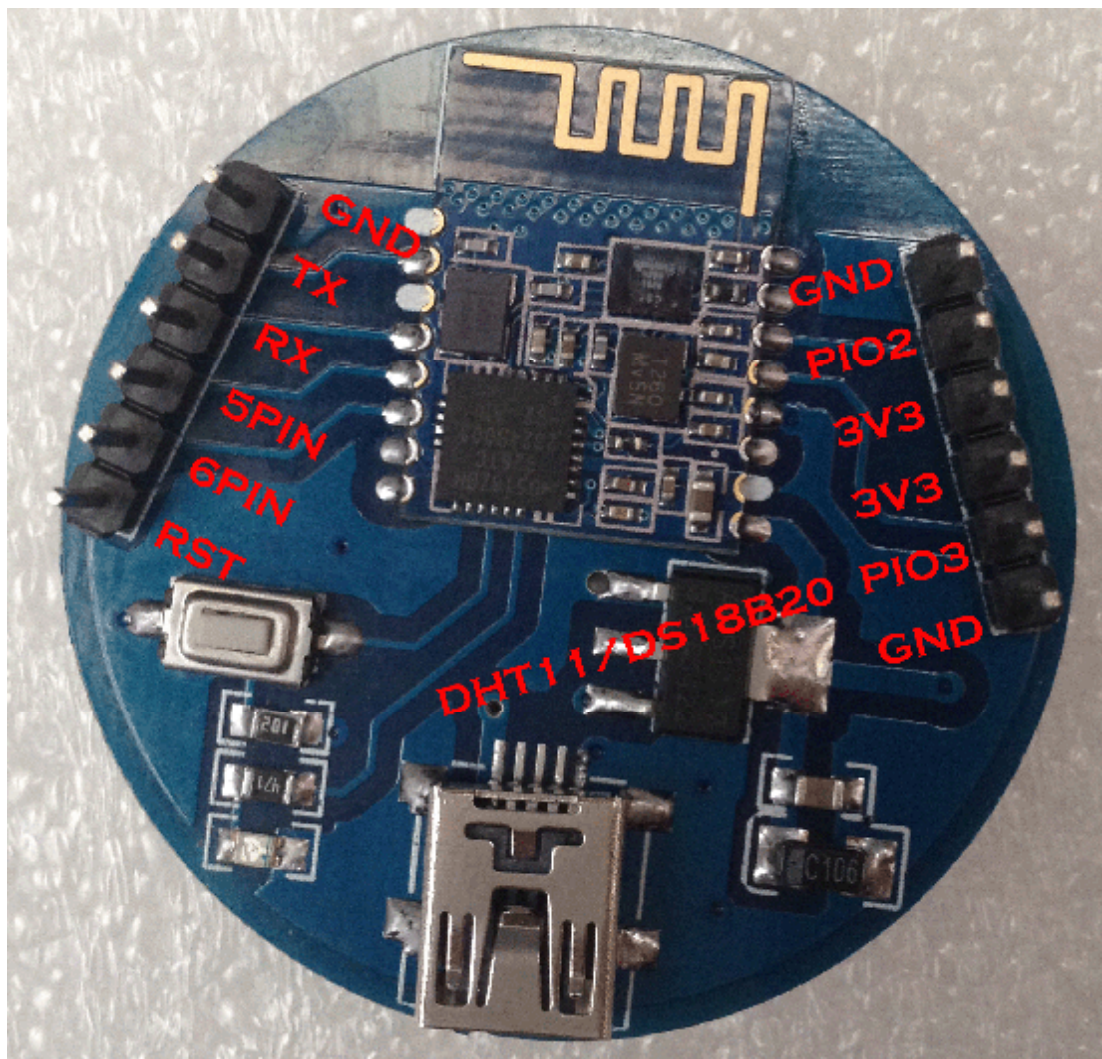

7. System function

How to wake up module from sleep mode?

There are two ways to wake up module from sleep mode, if module was in sleep mode..

7.1 Send "I am iron man, I am iron man, I am iron man I am iron....." string.

Yes, that's a joke, in sleep mode, you can send a long string (Length > 80 or more), that string can made module wake up, and you will receive "OK+WAKE" string from UART. Note: That wake up string is better not include any AT commands.

7.2 Long press system KEY ≥ 1000 ms.

After wake up module, you can send and receive AT commands.

How to let module into sleep mode?

1. Send "AT+SLEEP" string through UART, if all is okay, module will return

- “OK+SLEEP” string and into sleep mode.
2. Execute “AT+PWRM1” command, Module will auto into sleep mode when power on or disconnect from remote device.

System advert packet

In iOS system you can't get model MAC address directly. So we put MAC address information into advert packet.

You can use CBAvertisementDataManufactureDataKey property to get it, MAC address information string format like follow:

Total length is 8 Bytes, First of two bytes is identify string, it always is 0x48 and 0x4D, the rest 6 bytes is MAC address string

For example: 0x48, 0x4D, 0xB4, 0x99, 0x4C, 0xXX, 0xXX, 0xXX

0x48 and 0x4D is “HM” string.

0xB4: 0x99: 0x4C: 0xXX: 0xXX: 0xXX is BLE MAC Address.

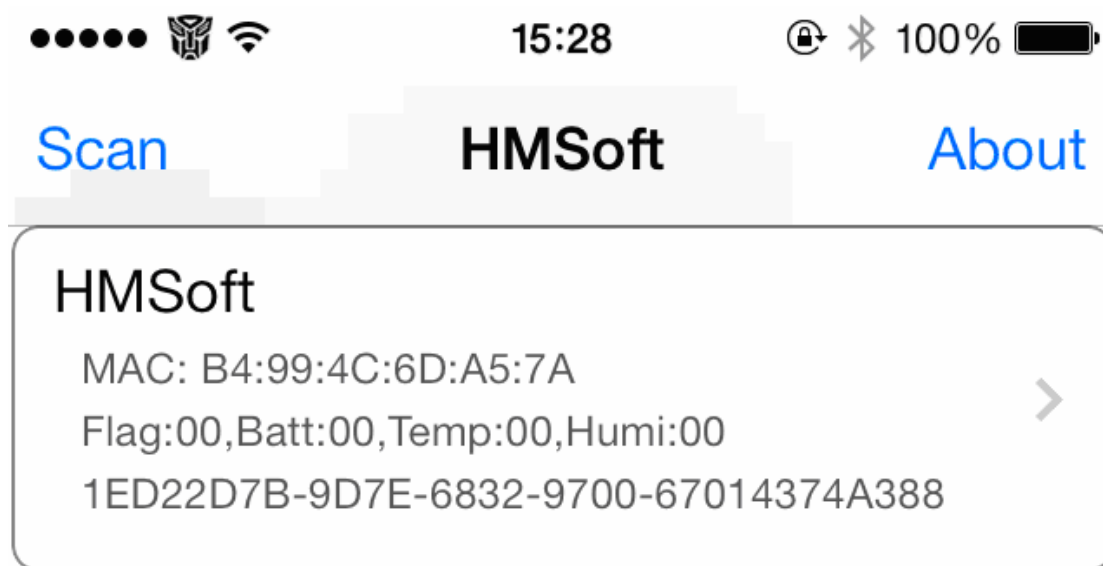

System KEY function (PIO0)

Press if Low > 1000ms:

7.3.1 If Module is in sleep mode

Module will wake up immediately, if AT+NOTI value is “1”, module will send “OK+WAKE” string through UART.

7.3.2 If Module has already connected to remote device

Module will disconnect from remote device.

7.3.3 If Module is standby mode

Module will reset to default configuration. Then restart.

System LED function (PIO1)

In sleep mode, LED has turned off.

If AT+PIO10 is setup

Unconnected status: Output High 500 ms, Low 500 ms

Connected status: Output High

If AT+PIO11 is setup

Unconnected status: Output Low.

Connected status: Output High.

System work Mode

A) Mode 0(Transmission mode, command string: AT+MODE0):

Before connect, you can configure module parameters with AT Commands

After connect, you can send and receive Bluetooth data through UART.

B) Mode 1(PIO acquisition mode, command string: AT+MODE1):

Before connect, you can configure module parameters with AT Commands

After connect

1) Send and receive Bluetooth data through UART.

2) Remote device could configure module parameters with AT Commands

3) Remote device could control PIO2 and PIO3 output low or high with AT

Commands

HM-11 has no this function

4) Remote device could get PIO4 ~ 11 input status with AT Commands

HM-11 only has PIO2 and PIO3.

C) Mode 2 (Remote control mode command string: AT+MODE2):

Before connect, you can configure module parameters with AT Commands

After connect:

1) Send and receive Bluetooth data through UART.

2) Remote device could configure module parameters with AT Commands

3) Remote device could control PIO2~11 output low or high

HM-11 only has PIO2 and PIO3.

8 AT Commands

Factory default setting:

Name: HMSoft; Baud: 9600, N, 8, 1; Pin code: 000000; Peripheral Role; transmit mode.

AT Command format:

Uppercase AT command format. string format, without any other symbol. (e.g. \r or \n). Since V6xx, module accept more style when you use command through UART.

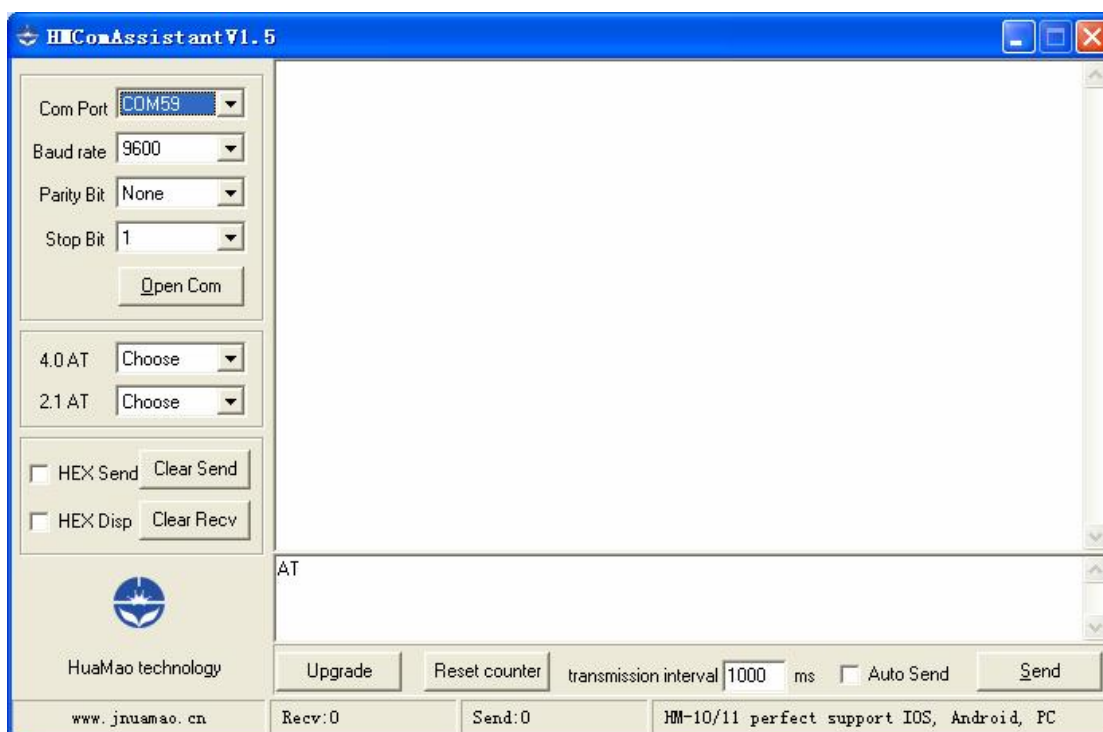

On Transmit version: module only accept AT Commands from UART interface when Bluetooth device is not connected with remote device.

On Remote version: module could accept AT Command from UART interface when Bluetooth Device is not connected with remote device, Also could accept AT Command from remote Bluetooth device when connected that.

On PIO collection version: module only accept AT Command from UART interface when Bluetooth device is not connected with remote device. After connect with remote device, module could accept and execute AT Command send from remote side.

1. Test Command or Disconnect Command

Send	Receive	Parameter
AT	OK OK+LOST	None

If Module is not connected to remote device will receive: "OK"

If Module is connected, module will disconnected from remote device, if "AT + NOTI" is setup to 1, module will output "OK+LOST" through UART.

2. Query module address

Send	Receive	Parameter
AT+ADC[P1]?	OK+GET:0.00	P1: 3,4,5,6,7,8,9,A,B map to PIO3~PIOB

HM-11 has no this function.

Add since V526.

3. Query module address

Send	Receive	Parameter
AT+ADDR?	OK+ADDR:MAC Address	None

3. Query/Set Advertising interval

Send	Receive	Parameter
AT+ADVI?	OK+ Get:[P1]	None
AT+ADVI[P1]	OK+ Set:[P1]	P1: 0 ~ F 0: 100ms 1: 152.5 ms 2: 211.25 ms 3: 318.75 ms 4: 417.5 ms 5: 546.25 ms 6: 760 ms 7: 852.5 ms

		8: 1022.5 ms 9: 1285 ms A: 2000ms B: 3000ms C: 4000ms D: 5000ms E: 6000ms F: 7000ms Default: 9 HMSoft Default: 0 HMSensor Default: 9
--	--	--

The maximum 1285ms recommendations form the IOS system. That is to say, 1285ms is apple allowed, but in response to scan and connected all the time will be long.

This command is added since V517 version.

V522 allow max value F.

4. Query/Set Advertising Type

Send	Receive	Parameter
AT+ADTY?	OK+ Get:[P1]	None
AT+ADTY[P1]	OK+ Set:[P1]	P1: 0 ~ 3 0: Advertising ScanResponse, Connectable 1: Only allow last device connect in 1.28 seconds 2: Only allow Advertising and ScanResponse. 3: Only allow Advertising Default: 0

Added since V519

5. Query/Set apple ANCS switch

Send	Receive	Parameter
AT+ANCS?	OK+ Get:[P1]	None
AT+ANCS[P1]	OK+ Set:[P1]	P1: 0 ~ 1 0: Off 1: On Default: 0

Note1: This command added in V524.

Note2: Please send AT+RESET to restart module if you set value 1.

Note3: Must execute AT+TYPE3 first.

6. Query/Set white list switch

Send	Receive	Parameter
AT+ALLO?	OK+ Get:[P1]	None
AT+ALLO[P1]	OK+ Set:[P1]	P1: 0 ~ 1 0: Off 1: On Default: 0

Note1: This command added in V523.

Note2: White List allows three MAC address link to module. Please use AT+AD command set white list MAC address.

7. Query/Set white list MAC address

Send	Receive	Parameter
AT+AD[P1]??	OK+ Get:[P2]	None
AT+AD[P1][P2]	OK+ Set:[P2]	P1: 1, 2, 3 P2: MAC address P1 default value: 0

Note1: This command added in V523.

E.g.

Send AT+AD1001122334455

Recv OK+Set:001122334455

8. Query/Set Module pin output state, After power supplied

Send	Receive	Parameter
AT+BEFC?	OK+ Get:[P1]	None
AT+BEFC[P1]	OK+ Set:[P1]	P1: 000~ 3FF; Hex format Default: 000

This command added in V527.

Hex 0x3FF change to binary format is 001111111111, total length is 12 bit, left to right side is map to module PIO0~PIOB, PIO0 and Plo1 is used by system, So must be 0. Only Pio2~PIOB pins is available.

e.g. Set PIO2~PIOB all output high after power supplied.

Send: AT+BEFC3FF

Recv:OK+Set:3FF

When next time power on, module PIO2~PIOB will output high.

Note: Query PIO pins current state please use AT+PIO?? Command.

Note: Please don't use this command when "AT+MODE1" is setup.

9. Query/Set Module pin output state, After connection is established

Send	Receive	Parameter
AT+AFTC?	OK+ Get:[P1]	None
AT+AFTC[P1]	OK+ Set:[P1]	P1: 000~ 3FF; Hex format Default: 000

This command added in V527.

Hex 0x3FF change to binary format is 001111111111, total length is 12 bit, Left to right side is map to module PIO0~PIOB, PIO0 and Plo1 is used by system. So must bo 0, Only Pio2~PIOB pins is available.

e.g. Set PIO2~PIOB all output high when connection is established.

Send: AT+AFTC3FF

Recv: OK+Set:3FF

When Bluetooth connection is established, module PIO2~PIOB will output high.

Note: Query PIO pins current state please use “AT+PIO??” command.

Note: Please don't use this command when “AT+MODE1” is setup.

10. Query/Set battery monitor switch

Send	Receive	Parameter
AT+BATC?	OK+ Get:[P1]	None
AT+BATC[P1]	OK+ Set:[P1]	P1: 0 ~ 1 0: Off 1: On Default: 0

This command added in V520

When AT+BATC1 command is executed, module will add battery information into scan response data package.

11. Query battery information

Send	Receive	Parameter
AT+BATT?	OK+BATT:[P1]	P1: 000~100

There has three ways to get battery information:

- a. Before establishing a connection, Send “AT+BATT?” through UART.
- b. After established a connection, In Mode 1 or 2, remote side send “AT+BATT?”

Battery information has included in scan response data package, one hour update once. You can use Android or IOS discovery module, when module has been discovered, you can get it from scan result array.

Data format is 0x02, 0x16, 0x00, 0xB0, [FLAG], [temperature], [humidity], [battery].

Android:

Included in OnLeScan function result array, you can see it direct.

```
private BluetoothAdapter.LeScanCallback mLeScanCallback = new BluetoothAdapter.LeScanCallback() {

    @Override

    public void onLeScan(final BluetoothDevice device, int rssi,

        byte[] scanRecord) {

        .....<Other code>.....
    }
}
```

```

String sBatt = ""; //Battery

String sTemp = ""; //Temperature

String sHumi = ""; //Humidity

for(int i = 0; i < scanRecord.length; i++)

{

    if(i + 7 < scanRecord.length)

    {

        //Since V522

        if(scanRecord[i] == 0x07 && scanRecord[i + 1] == 0x16

            && scanRecord[i + 2] == 0x00 && scanRecord[i + 3] == 0xB0)

        {

            if(scanRecord[i + 7] > 0)

                sBatt = String.valueOf(scanRecord[i + 7]);

            if(scanRecord[i + 5] > 0)

                sTemp = String.valueOf(scanRecord[i + 5]);

            if(scanRecord[i + 6] > 0)

                sHumi = String.valueOf(scanRecord[i + 6]);

        }

    }

}

.....<Other code>.....

}

};

```

iOS:

- c. Included in LeScan function result NSDictionary struct, service id is 0xB000.

12. Set battery information byte in advertising data

Send	Receive	Parameter
------	---------	-----------

AT+BATT[P1]	OK+Set:[P1]	P1: 0x00~0xFF Not include '?'
-------------	-------------	----------------------------------

Required: AT+BATC0

This command is used to set battery information byte in advertising data when you closed module power monitor, You can use battery information byte in advertising package for other purposes.

13. Query/Set 7 Bit format

Send	Receive	Parameter
AT+BIT7?	OK+Get:[P1]	P1: bit7 switch.
AT+BIT7[P1]	OK+Set:[P1]	0-----Not compatible 1-----Compatible Default: 0

This command is used only for compatible uses 7 data bits, 2 stop bit device.

14. Query/Set UART baud rate

Send	Receive	Parameter
AT+BAUD?	OK+Get:[P1]	P1: Baud rate No.
AT+BAUD[P1]	OK+Set:[P1]	0-----9600 1-----19200 2-----38400 3-----57600 4-----115200 5-----4800 6-----2400 7-----1200 8-----230400 Default: 0(9600)

e.g.

Query baud rate:

Send: AT+BAUD?

Receive: OK+Get:0

Setup baud rate:

Send: AT+BAUD1

Receive: OK+Set:1

Note: If setup to Value 7, After next power on, module will not support any AT Commands, until PIO0 is pressed, Module will change Baud to 9600.

15. Query/Set Minimum Link Layer connection interval

Send	Receive	Parameter
AT+COMI?	OK+Get:[P1]	P1: 0 ~ 9
AT+COMI[P1]	OK+Set:[P1]	Default: 3(20ms)

P1 Value: 0: 7.5ms; 1: 10ms; 2: 15ms; 3: 20ms; 4: 25ms; 5: 30ms; 6: 35ms; 7: 40ms; 8: 45ms; 9: 4000ms

Note: This command is added since V538

16. Query/Set Maximum Link Layer connection interval

Send	Receive	Parameter
AT+COMA?	OK+Get:[P1]	P1: 0 ~ 9
AT+COMA[P1]	OK+Set:[P1]	Default: 7(40ms)

P1 Value: 0: 7.5ms; 1: 10ms; 2: 15ms; 3: 20ms; 4: 25ms; 5: 30ms; 6: 35ms; 7: 40ms; 8: 45ms; 9: 4000ms

Note: This command is added since V538

17. Query/Set Link Layer connection slave latency

Send	Receive	Parameter
AT+COLA?	OK+Get:[P1]	P1: 0 ~ 4
AT+COLA[P1]	OK+Set:[P1]	Default: 0

Note: This command is added since V538

18. Query/Set connection supervision timeout

Send	Receive	Parameter
AT+COSU?	OK+Get:[P1]	P1: 0 ~ 6
AT+COSU[P1]	OK+Set:[P1]	Default: 6(6000ms)

P1 Value: 0: 100ms; 1: 1000ms; 2: 2000ms; 3: 3000ms; 4: 4000ms; 5: 5000ms; 6: 6000ms;

Note: This command is added since V538

19. Query/Set The Switch of update connection Parameter

Send	Receive	Parameter
AT+COUP?	OK+Get:[P1]	P1: 0 ~ 1
AT+COUP[P1]	OK+Set:[P1]	0: Don't update 1: Update Default: 1(update)

This command is only use when module is in slave role.

Note: This command is added since V538

20. Query/Set Characteristic

Send	Receive	Parameter
AT+CHAR?	OK+Get:[P1]	P1: 0x0001~0xFFFE
AT+CHAR[P1]	OK+Set:[P1]	Default: 0xFFE1

e.g. change characteristic value to 0xAAA0

Send: AT+CHAR0xAAA0

Recv: OK+Set:0xAAA0

21. Clear Last Connected device address

Send	Receive	Parameter
AT+CLEAR	OK+CLEAR	None

Notice: Only Central role is used.

22. Try connect to last succeeded device

Send	Receive	Parameter
AT+CONNL	OK+CONN[P1]	P1: L, E, F, N L: Connecting E: Connect error F: Connect Fail N: No Address

Notice: Only Central role is used.

Required: AT+IMME1 and AT+ROLE1 and AT+SAVE1.

If remote device has already connected to other device or shut down, "OK+CONN" will received after about 10 seconds.

23. Try to connect an device use MAC address

Send	Receive	Parameter
AT+CO[P0][P1]	OK+CO[P0][P0][P2]	P0: N, 0, 1, 2; 1 Byte Length N: Normal Address 0: Static MAC 1: Static random MAC 2: Random MAC P1: Address Like: 0017EA090909 P2: A, E, F; 1 Byte Length A: Connecting E: Connect error F: Connect Fail

Notice: Only central role is used.

Required: AT+IMME1 and AT+ROLE1.

If remote device has already connected to other device or shut down, "OK+CONN" will received after about 10 Seconds.

e.g.

Try to connect an device which MAC address is 00:17:EA:09:09:09

Send: AT+CON0017EA090909

May receive a reply:

- OK+CONNA ===== Accept request, connecting
- OK+CONNE ===== Connect error
- OK+CONN ===== Connected, if AT+NOTI1 is setup
- OK+CONN ===== Connect Failed, After 10 seconds

Note: 0 is not zero

24. Try to connect an device use MAC address and UUIDs

Send	Receive	Parameter
AT+CO[P0][P1][P3][P4]	OK+CO[P0][P0][P2]	P0: N, 0, 1, 2; 1 Byte Length N: Normal Address 0: Static MAC 1: Static random MAC 2: Random MAC P1: Address Like: 0017EA090909 P2: A, E, F; 1 Byte Length A: Connecting E: Connect error F: Connect Fail

Notice: Only central role is used.

Required: AT+IMME1 and AT+ROLE1 and AT+COMP1.

This command added since V604

This command is based on AT+CO command, modified in V604, added UUIDs support.

P3: Device UUID which one is included Write or WriteWithoutResponse property.
 4 Bytes Length, HEX format.

P4: Device UUID which one is included Notify property.
 4 Bytes Length, HEX format.

This command is used to Communication with different brand BLE device. This command let module know which UUIDs are using.

If the slave module what you want to communication is using 16 Bit UUID. And this device is using one or two Characteristics (Notify property and Write or WriteWithoutResponse property), then you can use this command to communication.

25. Try to connect an device use MAC address and UUIDs handle

Send	Receive	Parameter
AT+LN[P0][P1][P3][P4][P5]	OK+LN[P0][P0][P2]	P0: N, 0, 1, 2; 1 Byte Length N: Normal Address 0: Static MAC 1: Static random MAC 2: Random MAC P1: Address Like: 0017EA090909 P2: A, E, F; 1 Byte Length A: Connecting E: Connect error F: Connect Fail

Notice: Only central role is used.

Required: AT+IMME1 and AT+ROLE1.

This command added since V605

P3: Notify UUID handle, 4 Byte Length, HEX format, 0x0000 ~ 0xFFFF

P4: Write or Write_Without_Response UUID handle, 4 Bytes Length, HEX format, 0x0000~0xFFFF.

P5: Write method, 1 Byte length, values: 0: Write; 1: WriteWithoutResponse.

This command is used to communication with different brand BLE device.

This command not care UUIDs value, only care UUIDs handle, Use this command, you can talk with 16 Bit UUID device and 128 Bit UUID device.

26. Connect to an Discovered device use array index

Send	Receive	Parameter
AT+CONN[P1]	OK+CONN[P2]	P1: 0~5 P2: E, F, 0~5 E: Link error F: Link failed 0~5: Array index.

This command is use after execute AT+DISC?

AT+DISC? command will return discovered devices

The first discovered device array index is 0, second device array index is 1, AT+DISC? Command could return more than 6 devices, buy only first 6 device could use array index, other devices must use AT+CO or AT+LN command.

This command will clear all discovered data list.

27. Query PIO04~PIO11 input(output) state

Send	Receive	Parameter
AT+COL??	OK+ Col:[P1]	P1: 0x00~0xFF

P1 is a byte, has 8 bits, bit 7 ~ bit 0 is map to the PIO4 ~ PIO11.

This command is added since V515 version.

28. Query/Set PIO collection rate

Send	Receive	Parameter
AT+CYC??	OK+ Get:[P1]	P1: 00~99
AT+CYC[P1]	OK+ Set:[P1]	Unit: seconds Default: 10

Required AT+MODE1, when PIO state is change, module will send OK+Col:[xx] to UART or remote side. This command is set send interval.

This command is added since V515 version.

29. Query/Set The switch of study function

Send	Receive	Parameter
AT+COMP?	OK+ Get:[P1]	P1: 0, 1, ?
AT+COMP[P1]	OK+ Set:[P1]	?: Query; 0: Off; 1: On Default: 0

This command is used to communication with other brand BLE device with different UUIDs.

Please reference <How_To_Use_HM-1x_Study_function.pdf>

This command is added since V542 version.

30. Start a device discovery scan

Send	Receive	Parameter
AT+DISC?	OK+DISCS OK+DIS[P0][P1][P2] OK+DISCE	P0: C, 0, 1, 2; 1 Byte Length C: Common string 0~2: device Address type P1: device MAC string 6 Bytes length DISCS: Start discovery DISCE: End discovery

Required: AT+ROLE1, AT+IMME1

AT+SHOW command module help you to get more device information.

OK+DISCS is mean: module start discovery now.

OK+DISCE is mean: module already stopped discovery.

e.g.

Send: AT+DISC?

Recv: OK+DISCS

Recv: OK+DIS[P0]:123456789012 (discovered device address information)

If AT+SHOW1 is setup, you will receive the name information like follow

Recv: OK+NAME: xxx

After send Name value, will send two extra “\r\n” value ASCII byte

If AT+SHOW2 is setup, you will receive the RSSI information like follow

Recv: OK+RSSI: xxx\r\n

If AT+SHOW3 is setup, you will received both the RSSI information and Name information

Recv: OK+DIS[P0]:234567890123

Recv: OK+NAME: xxx\r\n

Recv: OK+RSSI: xxx\r\n

.....

Recv: OK+DISCE

After AT+DISC? Command, you will need to choose a device to connect, You

can use **AT+CONN** command or **AT+CO** command or **AT+LN** command. Or you can use **AT+DISI?** Command or **AT+DISA?** Command to get more different information.

31. Start a iBeacon device discovery scan

Send	Receive	Parameter
AT+DISI?	OK+DISC[P0:P1:P2:P3:P4]	P0: Factory ID P1: iBeacon UUID P2: Major Value Minor Value Measured Power P3: MAC P4: RSSI

Please set AT+ROLE1 and AT+IMME1 first.

e.g.

Send: AT+DISI?

Recv: OK+DISCS (Scan start)

Recv: OK+DIS[P0:P1:P2:P3:P4] (if have one device)

Recv: OK+DIS[P0:P1:P2:P3:P4] (if have two devices)

.....

Recv: OK+DISCE (Scan end)

P0 length is 8 Bytes; P1 length is 32 Bytes; P2 length is 10 Bytes; P3 length is 12 Bytes, P4 length is 4 Bytes, Those values all is ASCII mode.

P2 include Major Value (length 4 Bytes);

Minor Value (length 4 Bytes);

Measured Power (length 2 Bytes)

If the device not enable iBeacon function, P0, P1, P2 will use '0' to fill in.

Note: Added since V539

32. Start a full information device discovery scan

Send	Receive	Parameter
------	---------	-----------

AT+DISA?	OK+DISAS -> Start scan OK+DISC[P0:P1:P2:P3:P4] OK+DISAE -> Scan finished	P0: Device MAC (6Byte) P1: Device Type(1Byte) P2: Device RSSI(1Byte) P3: Rest Data Length (1Byte) P4: Rest Data
----------	--	--

Please set AT+IMME1 and AT+ROLE1 first.

Note: P3 and P4 All data is in Hex format.

Added in V547

33. Query/Set iBeacon deploy mode

Send	Receive	Parameter
AT+DELO[P1]	OK+DELO[P1]	P1: 1, 2 1: Allowed to broadcast and scanning 2: Only allow broadcast

After receive OK+DELO[P1], module will reset after 500ms.

This command will let module into non-connectable status until next power on.

34. Remove bond information

Send	Receive	Parameter
AT+ERASE	OK+ERASE	NONE

Note: Added in V524 version.

35. Set module use one Characteristic UUID or two Characteristics UUID

Send	Receive	Parameter
AT+FFE2[P1]	OK+ Set:[P1]	P1: ?, 0, 1, 2 ?: Query 0: Only use one Characteristic, Please look at AT+CHAR command 2: Use two Characteristics Second Char value = first Char value + 1

		Second value = AT+CHAR value + 1 3: Use two Characteristic Second Char value = first Char value – 1 Second value = AT+CHAR value – 1
--	--	---

Note: This command added since V550.

36. Set advertising package FLAG byte

Send	Receive	Parameter
AT+FLAG[P1]	OK+ Set:[P1]	P1: 00~FF (one byte)

Note: This command added in V530.

This command is used to set flag information byte in advertising package for other purposes.

37. Query/Set UART flow control switch

Send	Receive	Parameter
AT+FIOW?	OK+ Get:[P1]	P1: 0, 1
AT+FIOW[P1]	OK+ Set:[P1]	0: Off 1: On Default: 0

38. Query/Set module RX gain

Send	Receive	Parameter
AT+GAIN?	OK+ Get:[P1]	P1: 0, 1
AT+GAIN[P1]	OK+ Set:[P1]	0: No RX gain 1: Open RX gain Default: 0

Note: This command is added since V535

39. System Help Information

Send	Receive	Parameter
AT+HELP?	Help Information	None

40. Set Humi information byte in advertising data

Send	Receive	Parameter
------	---------	-----------

AT+HUMI[P1]	OK+Set:[P1]	P1: 0x00~0xFF
-------------	-------------	---------------

This command is used to set humi information byte in advertising data when you doesn't want to use humi function buy want to use as AT+FLAG command.

Added in V544

41. Query/Set Module work type

Send	Receive	Parameter
AT+IMME?	OK+ Get:[P1]	P1: 0, 1 1: When module is powered on, only respond the AT Command, don't do anything. Until AT + START, AT+CON, AT+CONNL commands is received. 0: When power on, module will start work immediately Default: 0
AT+IMME[P1]	OK+ Set:[P1]	

This command is only used for Central role.

42. Query/Set Module iBeacon switch

Send	Receive	Parameter
AT+IBEA?	OK+Get:[P1]	P1: 0, 1 0: Turn off iBeacon 1: Turn on iBeacon Default: 0
AT+IBEA[P1]	OK+Set:[P1]	

iBeacon UUID is: 74278BDA-B644-4520-8F0C-720EAF059935.

This command is added since V517 version.

43. Query/Set iBeacon UUID

Send	Receive	Parameter
AT+IBE0?	OK+Get:[P1]	P1: 00000001~ FFFFFFFE Default: 74278BDA
AT+IBE0[P1]	OK+Set:[P1]	

Default iBeacon UUID is: 74278BDA-B644-4520-8F0C-720EAF059935.

This command can change red color string in iBeacon UUID.

This command is added since V520 version.

e.g.: Send: AT+IBE012345678 change iBeacon UUID red color string to "12345678"

44. Query/Set iBeacon UUID

Send	Receive	Parameter
AT+IBE1?	OK+Get:[P1]	P1: 00000001~
AT+IBE1[P1]	OK+Set:[P1]	FFFFFFFE Default: B6444520

iBeacon UUID is: 74278BDA-B644-4520-8F0C-720EAF059935.

This command can change red color string in iBeacon UUID.

This command is added since V520 version.

e.g.: Send: AT+IBE112345678 change iBeacon UUID red color string to "12345678"

45. Query/Set iBeacon UUID

Send	Receive	Parameter
AT+IBE2?	OK+Get:[P1]	P1: 00000001~
AT+IBE2[P1]	OK+Set:[P1]	FFFFFFFE Default: 8F0C720E

iBeacon UUID is: 74278BDA-B644-4520-8F0C-720EAF059935.

This command can change red color string in iBeacon UUID.

This command is added since V520 version.

e.g.: Send: AT+IBE112345678 change iBeacon UUID red color string to "12345678"

46. Query/Set iBeacon UUID

Send	Receive	Parameter
AT+IBE3?	OK+Get:[P1]	P1: 00000001~
AT+IBE3[P1]	OK+Set:[P1]	FFFFFFFE

		Default: AF059935
--	--	-------------------

iBeacon UUID is: 74278BDA-B644-4520-8F0C-720EAF059935.

This command can change red color string in iBeacon UUID.

This command is added since V520 version.

e.g.: Send: AT+IBE112345678 change iBeacon UUID red color string to "12345678"

47. Query/Set Module iBeacon Marjor version

Send	Receive	Parameter
AT+MARJ?	OK+Get:[P1]	P1: 0x0001, 0xFFFE
AT+MARJ[P1]	OK+Set:[P1]	Default: 0xFFE0

E.g. Change marjor version to 0x0102

Send: AT+MARJ0x0102, if all is okay, module will send back OK+Set: 0x0102

This command is added since V517 version.

48. Query/Set Module iBeacon minor

Send	Receive	Parameter
AT+MINO?	OK+Get:[P1]	P1: 0x0001, 0xFFFE
AT+MINO[P1]	OK+Set:[P1]	Default: 0xFFE1

This command is added since V517 version.

49. Query/Set Module iBeacon Measured power

Send	Receive	Parameter
AT+MEAS?	OK+Get:[P1]	P1: 0x01~ 0xFF
AT+MEAS[P1]	OK+Set:[P1]	Default: 0xC5

This command is added since V519 version.

50. Query/Set Module Work Mode

Send	Receive	Parameter
AT+MODE?	OK+Get:[P1]	P1: 0, 1, 2
AT+MODE[P1]	OK+Set:[P1]	0: Transmission Mode 1: PIO collection Mode + Mode 0

		2: Remote Control Mode + Mode 0 Default: 0
--	--	--

Mode 0:

Before establishing a connection, you can use the AT command configuration module through UART.

After established a connection, you can send data to remote side from each other.

Mode 1:

Before establishing a connection, you can use the AT command configuration module through UART.

After established a connection, you can send data to remote side. Remote side can do fellows:

Send AT command configuration module.

Collect PIO04 to the PIO11 pins input state of HM-10.

Collect PIO03 pins input state of HM-11.

Remote control PIO2, PIO3 pins output state of HM-10.

Remote control PIO2 pin output state of HM-11.

Send data to module UART port (not include any AT command and per package must less than 20 bytes).

Mode 2:

Before establishing a connection, you can use the AT command configuration module through UART.

After established a connection, you can send data to remote side. Remote side can do fellows:

Send AT command configuration module.

Remote control PIO2 to PIO11 pins output state of HM-10.

Remote control PIO2, PIO3 pins output state of HM-11.

Send data to module UART port (not include any AT command and per package

must less than 20 bytes).

51. Query/Set Notify information

Send	Receive	Parameter
AT+NOTI?	OK+Get:[P1]	P1: 0, 1
AT+NOTI[P1]	OK+Set:[P1]	0: Don't Notify 1: Notify Default: 0

If this value is set to 1, when link ESTABLISHED or LOSTED module will send OK+CONN or OK+LOST string through UART.

52. Query/Set notify mode

Send	Receive	Parameter
Q: AT+NOTP?	OK+ Get[P1]	P1: 0, 1; default: 0
Q: AT+NOTP[P1]	OK+ Set[P1]	0: without address 1: with address

This command must work with "AT+NOTI1", if this switch is open, when the module connect to disconnect, the prompt string will include the remote address.

OK+CONN:001122334455 String "001122334455" is the MAC address string

Added since V534

53. Query/Set Module name

Send	Receive	Parameter
AT+NAME ?	OK+NAME[P1]	P1: module name, Max length is 12.
AT+NAME[P1]	OK+Set[P1]	Default: HMSoft

e.g.

change module name to bill_gates

Send: AT+NAMEbill_gates

Receive: OK+SetName:bill_gates

54. Query/Set output driver power

Send	Receive	Parameter
------	---------	-----------

Query: AT+PCTL?	OK+Get:[P1]	None
Set: AT+PCTL[P1]	OK+Set:[P1]	P1: 0,1 0:Normal power output 1:Max power output Default: 1

Noted: Added in V527

55. Query/Set Parity bit

Send	Receive	Parameter
Query: AT+PARI?	OK+Get:[P1]	None
Set: AT+PARI[P1]	OK+Set:[P1]	P1: 0,1,2 0:None 1:ODD 2:EVEN Default: 0 (None)

56. Query/Set PIO1 output status (System LED)

Send	Receive	Parameter
AT+PIO1?	OK+Get:[P1]	P1: 0, 1
AT+ PIO1 [P1]	OK+Set:[P1]	0: Unconnected Output 500ms High 500ms Low, Connected output High. 1: Unconnected output Low, Connected output High. Default: 0

57. Query/Set PIO pins output high or low (Only this time, when module next power on, this value is not be used)

Send	Receive	Parameter
AT+PIO[P1]?	OK+PIO:[P1][P2]	P1: 2~B, ?
AT+PIO[P1][P2]	OK+PIO:[P1][P2]	P2: 0, 1, ? HM-11 only has 4 pins.

		<p>P1 is which PIO pin you want to Query/Set Value: 2,3,4,5,6,7,8,9,A,B. P2 is Query or setup value. "0" is low and "1" is high and "?" is query</p>
--	--	--

e.g.

Query PIO2

Send: AT+PIO2?

Setup PIO2 output high

Send: AT+PIO21

Receive: OK+PIO21

HM-10 HMSensor version: P1 value is 2~A

HM-10 HMSoft version: P1 value is 2~B

HM-11 HMSensor version: P1 value is 2

HM-11 HMSoft version: P1 value is 2, 3

V525 added PIO2 PWM function, P2 value is 0~9

0: output low

1: output high

2: output 100ms PWM

3: output 200ms PWM

.....

9: output 800ms PWM

V527 added AT+PIO?? Format query all pins output state.

58. Query/Set multiple PIO pins output high or low

Send	Receive	Parameter
AT+MPIO[P1]	OK+Set:[P1]	P1: 000 ~ 3FF; Hex format

This command added since V551

This command is used to control multiple PIO pins output HIGH or LOW.

P1 is Hex format, max value 3FF changed to binary format is 001111111111,

Total length is 12 bit, left side to right bit mapped to module PIO0 to PIOB,

Note: HM-11 only have PIO0, PIO1, PIO2,PIO3

1: is output HIGH;

0: is output LOW.

59. Query/Set Pin Code

Send	Receive	Parameter
AT+PASS?	OK+Get:[P1]	P1: 000000~999999
AT+PASS[P1]	OK+Set:[P1]	Default: 000000

e.g.

Query Pin Code

Send: AT+PASS?

Receive: OK+Get:000000

Setup Pin Code 008888

Send: AT+PASS008888

Receive: OK+Set:008888

60. Query/Set Module Power

Send	Receive	Parameter
AT+POWE?	OK+Get:[P1]	None
AT+POWE [P1]	OK+Set:[P1]	P1: 0 ~ 3 0: -23dbm 1: -6dbm 2: 0dbm 3: 6dbm Default: 2

61. Query/Set Module sleep type

Send	Receive	Parameter
AT+PWRM?	OK+Get:[P1]	None
AT+PWRM[P1]	OK+Set:[P1]	P1: 0~1

		0:Auto sleep 1:Don't auto sleep Default: 1
--	--	--

Only support peripheral role.

62. Query/Set reliable advertising mode

Send	Receive	Parameter
AT+RELI?	OK+ Get:[P1]	P1: 0, 1
AT+RELI[P1]	OK+ Set:[P1]	0: Normal advertising 1: Reliable advertising Default: 0

Note: This command is added since V530

This command is used to make sure module always send advertising package when module is in standby mode.

63. Restore all setup value to factory setup

Send	Receive	Parameter
AT+RENEW	OK+RENEW	None

64. Restart module

Send	Receive	Parameter
AT+RESET	OK+RESET	None

65. Query/Set Master and Slaver Role

Send	Receive	Parameter
AT+ROLE?	OK+Get:[P1]	P1: 0, 1
AT+ROLE[P1]	OK+Set:[P1]	0: Peripheral 1: Central Default: 0

66. Query RSSI Value

Send	Receive	Parameter
AT+RSSI?	OK+RSSI:[P1]	None

Require: AT+MODE value > 0

This command only used by Remote device query after connected.

67. Query Last Connected Device Address

Send	Receive	Parameter
AT+RADD?	OK+RADD:MAC Address	None

68. Query/Set Module Sensor work interval

Send	Receive	Parameter
AT+RAT??	OK+Get:[P1]	P1: 00~99
AT+RAT[P1]	OK+Set:[P1]	0:Save when connected 1:Don't Save Default: 0 Unit: minute

Note: This command is only use for HMSensor

69. Query/Set Stop bit

Send	Receive	Parameter
AT+STOP?	OK+Get:[P1]	None
AT+STOP[P1]	OK+Set:[P1]	P1:0, 1 0: One stop bit 1: Two stop bit Default: 0 (One stop bit)

70. Work immediately (Switch to auto work state)

Send	Receive	Parameter
AT+START	OK+START	None

This command is only used when AT+IMME1 is setup.

71. Query Module into sleep mode

Send	Receive	Parameter
AT+SLEEP	OK+SLEEP	None

Only support Peripheral role.

72. Query/Set Module save connected address information

Send	Receive	Parameter
------	---------	-----------

AT+SAVE?	OK+Get:[P1]	None
AT+SAVE[P1]	OK+Set:[P1]	P1: 0~1 0:Save when connected 1:Don't Save Default: 0

Note: After power on, if module checked this information, module will try to connect it until AT+TCN command setting timeout or AT+CLEAR command to clear this information, then module will into discovery mode.

73. Query/Set Module discovery time when module in master role

Send	Receive	Parameter
AT+SCAN?	OK+Get:[P1]	None
AT+SCAN[P1]	OK+Set:[P1]	P1: 1 ~ 9 Unit: Second Default: 3 Seconds

Note: Add in V543

74. Query/Set sensor type on module PIO11(HM-11 is PIO3)

Send	Receive	Parameter
AT+SENS?	OK+Get:[P1]	P1: 0, 1, 2
AT+SENS[P1]	OK+Set:[P1]	0: None 1: DHT11 2: DS18B20 Default: 0

Note: This command is use for HMSensor.

75. Query/Set if show device information when discovery

Send	Receive	Parameter
AT+SHOW?	OK+Get:[P1]	None
AT+SHOW[P1]	OK+Set:[P1]	P1: 0, 1, 2 0:Don't show information 1:Show name

		2: Show RSSI 3: Show RSSI and Name Default: 0
--	--	---

If AT+SHOW1 is setup, AT+DISC? Command will add the device name information into scan result package.

If AT+SHOW2 is setup, AT+DISC? Command will add device rssi information into scan result package.

If AT+SHOW3 is setup, AT+DISC? Command will add device name and rssi information into scan result package.

76. Query/Set Module Sensor Temperature and humidity(if has a sensor)

Send	Receive	Parameter
AT+TEHU?	OK+Get:[P1][P2]	P1: 000~120 P2: 000~100

Note: This command is only use for HMSensor version.

This value is added into scan response data package.

Data format is 0x02, 0x16, 0x00, 0xB0, [reserved], [temperature], [humidity], [battery].

Android:

Included in OnLeScan function result array, you can see it direct.

iOS:

Included in LeScan function result NSDictionary struct, service id is 0xB000.

77. Query DS18B20 Sensor or IC temperature

Send	Receive	Parameter
AT+TEMP?	OK+Get:[P1]	P1: 000.000~255.000

Note1: if not setup AT+SENS value, will get IC temperature.

Note2: Added in V523 version, Modified at V544.

78. Set temperature information byte in advertising data

Send	Receive	Parameter
------	---------	-----------

AT+TEMP[P1]	OK+Set:[P1]	P1: 0x00~0xFF Not include '?'
-------------	-------------	----------------------------------

This command is used to set temperature information byte in advertising data when you doesn't want to use temperature function buy want to use as AT+FLAG command.

Added in V544

79. Query/Set module connect remote device timeout value

Send	Receive	Parameter
AT+TCON?	OK+Get:[P1]	None
AT+TCON[P1]	OK+Set:[P1]	P1 is timeout value. When time is up, module will not connect this address anymore, then enter search mode. P1 allowed value: 000000~999999 Unit is ms. Default: 000000 Connect forever

This value is only used for Central Role, when module has Last Connected address.

80. Query/Set Module Bond Mode

Send	Receive	Parameter
AT+TYPE?	OK+Get:[P1]	None
AT+TYPE[P1]	OK+Set:[P1]	P1: 0~2 0:Not need PIN Code 1:Auth not need PIN 2:Auth with PIN 3:Auth and bonded

		Default: 0
--	--	------------

Important: If your module version is less than V515, please don't use this command.

Under android 4.3 AT+TYPE1 is same to AT+TYPE2.

Note: Value 3 is added in V524.

81. Query/Set service UUID value

Send	Receive	Parameter
AT+UUID?	OK+Get:[P1]	P1: 0x0001~0xFFFE
AT+UUID[P1]	OK+Set:[P1]	Default: 0xFFE0

e.g. Change UUID value to 0xAAA0

Send: AT+UUID0xAAA0

Recv: OK+Set:0xAAA0

82. Query/Set UART sleep type

Send	Receive	Parameter
AT+UART?	OK+Get:[P1]	P1: 0~1
AT+UART[P1]	OK+Set:[P1]	0: When module into sleep mode, you can wake up module through UART. 1: When module into sleep mode, also shutdown UART. Default: 0xFFE0

Note: This command is only use for HMSensor version.

83. Query Software Version

Send	Receive	Parameter
AT+VERR? AT+VERS?	Version Information	None

Resource:

Bluetooth Module 2.1 datasheet:

http://www.jnhuamao.cn/Bluetooth_en.zip

Bluetooth Module 4.0 datasheet:

http://www.jnhuamao.cn/Bluetooth40_en.zip

Bluetooth Module 4.0 USB Dongle

http://www.jnhuamao.cn/HMDongle40_en.zip

Bluetooth 2.1 Com Assistant for android:

<http://www.jnhuamao.cn/HMComAssistant.rar>

Bluetooth 4.0 Com Assistant for android 4.3:

<http://www.jnhuamao.cn/HMBLEComAssistant.rar>

Bluetooth 4.0 IOS Code:

http://www.jnhuamao.cn/HMSoft_iso7.zip

http://www.jnhuamao.cn/HMSoft_iso7.zip